



European Union Network for the Implementation  
and Enforcement of Environmental Law



Working Group  
Contamination

# Soil Washing (SW) report

---

*Final Report*

***Date of report: 31 January 2023***

***Report number: 2022/10 SW EN***

## Introduction to IMPEL

The European Union Network for the Implementation and Enforcement of Environmental Law (IMPEL) is an international non-profit association of the environmental authorities of the EU Member States, acceding and candidate countries of the European Union and EEA countries. The association is registered in Belgium and its legal seat is in Brussels, Belgium.

IMPEL was set up in 1992 as an informal Network of European regulators and authorities concerned with the implementation and enforcement of environmental law. The Network's objective is to create the necessary impetus in the European Community to make progress on ensuring a more effective application of environmental legislation. The core of the IMPEL activities concerns awareness raising, capacity building and exchange of information and experiences on implementation, enforcement and international enforcement collaboration as well as promoting and supporting the practicability and enforceability of European environmental legislation.

During the previous years IMPEL has developed into a considerable, widely known organisation, being mentioned in a number of EU legislative and policy documents, e.g. the 7th Environment Action Programme and the Recommendation on Minimum Criteria for Environmental Inspections.

The expertise and experience of the participants within IMPEL make the network uniquely qualified to work on both technical and regulatory aspects of EU environmental legislation.

Information on the IMPEL Network is also available through its website at: [www.impel.eu](http://www.impel.eu)

Suggested citation:

Falconi M. et al. (2023), Soil Washing (SW) report. IMPEL, COMMON FORUM, EIONET, NICOLE report no 2022/10 SW, 120 pages. Brussels, ISBN 978-2-931225-30-1



<b>Title of the report:</b> Soil Washing (SW) report	<b>Number report:</b> 2022/10 SW EN																																																						
<b>Report adopted at IMPEL General Assembly Meeting:</b> Approval by Written Procedure 14 February 2023	<b>Total number of pages: 120</b>  <b>Report: 33 pages</b> <b>Annexes: 87 pages</b>																																																						
<p><b>Project Managers:</b></p> <table border="0"> <tr> <td>Marco Falconi (IT)</td> <td>IMPEL</td> <td>ISPRA</td> </tr> <tr> <td>Dietmar Müller-Grabherr (AT)</td> <td>Common Forum</td> <td>Unweltbundesamt AT</td> </tr> <tr> <td>Frank Swartjes (NL)</td> <td>EIONET WG Contamination</td> <td>RIVM</td> </tr> <tr> <td>Wouter Gevaerts (NL)</td> <td>NICOLE</td> <td>Arcadis</td> </tr> </table> <p><b>Authors:</b></p> <table border="0"> <tr> <td>Iustina Boaja (RO)</td> <td></td> <td>Romanian Geological Survey</td> </tr> <tr> <td>Massimiliano Confalonieri (IT)</td> <td>IMPEL</td> <td>ARPA Lombardia</td> </tr> <tr> <td>Nazare Couto (PT)</td> <td></td> <td>CENSE</td> </tr> <tr> <td>Marco Falconi (IT)</td> <td>IMPEL</td> <td>ISPRA</td> </tr> <tr> <td>Gokberk Kara (TR)</td> <td></td> <td>RSK</td> </tr> <tr> <td>Kurt Morgan (SW)</td> <td></td> <td>KIBAG</td> </tr> <tr> <td>Dietmar Müller-Grabherr (AT)</td> <td>Common Forum</td> <td>Unweltbundesamt AT</td> </tr> <tr> <td>Andrea Sconocchia (IT)</td> <td>IMPEL</td> <td>ARPA Umbria</td> </tr> <tr> <td>Frank Swartjes (NL)</td> <td>EIONET</td> <td>RIVM</td> </tr> <tr> <td>Reto Tietz (SW)</td> <td>IMPEL</td> <td>FOMI</td> </tr> </table> <p><b>Contributors to Annex 1 ISCO:</b></p> <table border="0"> <tr> <td>Alessia Arelli (IT)</td> <td>ISPRA</td> </tr> <tr> <td>Paola Canepa (IT)</td> <td>ARPA Lombardia</td> </tr> <tr> <td>Massimiliano Confalonieri (IT)</td> <td>ARPA Lombardia</td> </tr> <tr> <td>ENVIT (SI)</td> <td>ENVIT</td> </tr> <tr> <td>Beatrice Melillo (IT)</td> <td>ARPA Lombardia</td> </tr> <tr> <td>Alessandro Teani (IT)</td> <td>AMBIENTHESIS</td> </tr> </table>		Marco Falconi (IT)	IMPEL	ISPRA	Dietmar Müller-Grabherr (AT)	Common Forum	Unweltbundesamt AT	Frank Swartjes (NL)	EIONET WG Contamination	RIVM	Wouter Gevaerts (NL)	NICOLE	Arcadis	Iustina Boaja (RO)		Romanian Geological Survey	Massimiliano Confalonieri (IT)	IMPEL	ARPA Lombardia	Nazare Couto (PT)		CENSE	Marco Falconi (IT)	IMPEL	ISPRA	Gokberk Kara (TR)		RSK	Kurt Morgan (SW)		KIBAG	Dietmar Müller-Grabherr (AT)	Common Forum	Unweltbundesamt AT	Andrea Sconocchia (IT)	IMPEL	ARPA Umbria	Frank Swartjes (NL)	EIONET	RIVM	Reto Tietz (SW)	IMPEL	FOMI	Alessia Arelli (IT)	ISPRA	Paola Canepa (IT)	ARPA Lombardia	Massimiliano Confalonieri (IT)	ARPA Lombardia	ENVIT (SI)	ENVIT	Beatrice Melillo (IT)	ARPA Lombardia	Alessandro Teani (IT)	AMBIENTHESIS
Marco Falconi (IT)	IMPEL	ISPRA																																																					
Dietmar Müller-Grabherr (AT)	Common Forum	Unweltbundesamt AT																																																					
Frank Swartjes (NL)	EIONET WG Contamination	RIVM																																																					
Wouter Gevaerts (NL)	NICOLE	Arcadis																																																					
Iustina Boaja (RO)		Romanian Geological Survey																																																					
Massimiliano Confalonieri (IT)	IMPEL	ARPA Lombardia																																																					
Nazare Couto (PT)		CENSE																																																					
Marco Falconi (IT)	IMPEL	ISPRA																																																					
Gokberk Kara (TR)		RSK																																																					
Kurt Morgan (SW)		KIBAG																																																					
Dietmar Müller-Grabherr (AT)	Common Forum	Unweltbundesamt AT																																																					
Andrea Sconocchia (IT)	IMPEL	ARPA Umbria																																																					
Frank Swartjes (NL)	EIONET	RIVM																																																					
Reto Tietz (SW)	IMPEL	FOMI																																																					
Alessia Arelli (IT)	ISPRA																																																						
Paola Canepa (IT)	ARPA Lombardia																																																						
Massimiliano Confalonieri (IT)	ARPA Lombardia																																																						
ENVIT (SI)	ENVIT																																																						
Beatrice Melillo (IT)	ARPA Lombardia																																																						
Alessandro Teani (IT)	AMBIENTHESIS																																																						
<p><b>Executive Summary</b></p> <p><i>Keywords</i>          Soil Washing, Sustainable Remediation, Soil, Groundwater, Soil Policy, Remediation, Environment, Pollution, Polluted sites, Contamination, Contaminated sites, Monitoring, In field test.</p> <p><i>Target groups</i>          Competent authorities for remediation technology approval/application/monitoring, industrial operators, environmental protection agencies, nature protection bodies, environmental inspectorates, environmental monitoring, and research institutions, technical universities, environmental associations, NGOs, insurance companies and associations, environmental consultants.</p> <p>As part of its 2020 Work Programme, the IMPEL Network set up this project Water and Land Remediation (2020/09), concerning the criteria for evaluating the applicability of remediation</p>																																																							

technologies.

The Water and Land Remediation project takes guidance on definitions and key steps of remediation technology application as a springboard and focuses on the technical procedures connected with the remediation technologies. The ultimate goal of the project is to produce a document proving criteria for the assessment of the proposal of remediation technology application, to understand the applicability, what to do in the field tests, and in the full-scale application. Annex 1 covers a number of case studies, that may help the reader to anticipate any problems they may encounter and see if the provided solution applies to their site, knowing that every contaminated site differs from others and it is ever needed a site-specific approach.

The Water and Land Remediation project for 2020-2021 has the objective was to concentrate on two remediation technologies, Multi Phase Extraction and Soil Washing.

Finally, Water and Land Remediation project intends to contribute to promoting the application of in situ and on-site remediation technologies for soil and groundwater, and less application of Dig & Dump and Pump & Treat that are techniques widely used in Europe but not sustainable in the middle-long term. Soil and water are natural resources and, when it is technically feasible, should be recovered not wasted.

### **Acknowledgements**

This report has been peer reviewed by a wider IMPEL project team and by the IMPEL Water and Land Expert Group, Common Forum network, NICOLE network, EIONET WG Contamination and a group of external reviewers.

# Disclaimer

---

This publication has been prepared within the IMPEL Water & Land Remediation project with the support of partner networks interested in Contaminated Land Management. Written and reviewed by a team of authors the document on hand intends to serve as primary information source to bridge and broaden knowledge among European countries and regions. In aiming support for a joint understanding the potentials of the specific remediation technology it seeks to facilitate.

The content reported here are on the basis of relevant bibliography, the authors' experience, and case studies collected. The document may not be extensive in all situations in which this technology has been or will be applied. Case studies (see annex) are acknowledged voluntary contributions. The team of authors had no task like evaluating or verifying case study reports.

As well some countries, regions, or local authorities may have launched particular legislation, rules, or guidelines to frame technology application and its applicability.

This document is NOT intended as a guideline or BAT Reference Document for this technology. The pedological, geological and hydrogeological settings of contaminated sites across Europe show a broad variability. Therefore tailor-made site-specific design and implementation is key for success in remediating contaminated sites. So the any recommendation reported could be applied, partially applied, or not applied. In any case, the authors, the contributors, the networks involved, cannot be deemed responsible.

The opinions expressed in this document are not necessarily those of the individual members of the undersigned networks. IMPEL and its partner networks strongly recommend that individuals/organisations interested in applying the technology in practice retain the services of experienced environmental professionals.

Marco Falconi – IMPEL

Dietmar Müller Grabherr – COMMON FORUM on Contaminated Land in Europe

Frank Swartjes – EEA EIONET WG Contamination

Wouter Gevaerts – NICOLE

# Glossary

TERM	DEFINITION	SOURCE	PARAGR.
'compliance point'	location (for example, soil or groundwater) where the assessment criteria shall be measured and shall not be exceeded	ISO EN 11074	3.4.5
'compliance or performance control'	investigation or program of on-going inspection, testing or monitoring to confirm that a remediation strategy has been properly implemented (for example, all contaminated have been removed) and/or when a containment approach has been adopted, that this continues to perform to the specified level	ISO EN 11074	6.1.5
'contaminant' <sup>1</sup>	substance(s) or agent(s) present in the soil as a result of human activity	ISO EN 11074	3.4.6
'contaminated site' <sup>2</sup>	site where contamination is present	ISO EN 11074	2.3.5
'contamination'	substance(s) or agent(s) present in the soil as a result of human activity	ISO EN 11074	2.3.6
'effectiveness' <sup>3</sup>	<remediation method> measure of the ability of a remediation method to achieve a required performance	ISO EN 11074	6.1.6
'emission'	the direct or indirect release of substances, vibrations, heat or noise from individual or diffuse sources in the installation into air, water or land;	IED	Art. 3 (4)
'environmental quality standard'	the set of requirements which must be fulfilled at a given time by a given environment or particular part thereof, as set out in Union law;	IED	Art. 3 (6)
'Henry's coefficient'	partition coefficient between soil air and soil water	ISO EN 11074	3.3.12
' <i>in-situ</i> treatment method' <sup>4</sup>	treatment method applied directly to the environmental medium treated (e.g. soil, groundwater) without extraction of the contaminated matrix from the ground	ISO EN 11074	6.2.3
'leaching'	dissolution and movement of dissolved substances by water	ISO EN 11074	3.3.15

<sup>1</sup> There is no assumption in this definition that harms results from the presence of contamination

<sup>2</sup> There is no assumption in this definition that harms results from the presence of contamination.]

<sup>3</sup> In the case of a process-based method, effectiveness can be expressed in terms of the achieved residual contaminant concentrations.

<sup>4</sup> Note: ISO CD 241212 suggests as synonym: 'in-situ (remediation) technique' [Note 1 to entry: Such remediation installation is set on site and the action of treating the contaminant is aimed at being directly applied on the subsurface.] ISO CD 24212 3.1

'pollutant'	substance(s) or agent(s) present in the soil (or groundwater) which, due to its properties, amount or concentration, causes adverse impacts on soil functions	ISO EN 11074	3.4.18
'pollution'	the direct or indirect introduction, as a result of human activity, of substances, vibrations, heat or noise into air, water or land which may be harmful to human health or the quality of the environment, result in damage to material property, or impair or interfere with amenities and other legitimate uses of the environment;	IED	Art. 3 (2)
'remediation objective'	generic term for any objective, including those related to technical (e.g. residual contamination concentrations, engineering performance), administrative, and legal requirements	ISO EN 11074	6.1.19
'remediation strategy' <sup>5</sup>	combination of remediation methods and associated works that will meet specified contamination-related objectives (e.g. residual contaminant concentrations) and other objectives (e.g. engineering-related) and overcome site-specific constraints	ISO EN 11074	6.1.20
'remediation target value'	indication of the performance to be achieved by remediation, usually defined as contamination-related objective in term of a residual concentration	ISO EN 11074	6.1.21
'saturated zone'	zone of the ground in which the pore space is filled completely with liquid at the time of consideration	ISO EN 11074	3.2.6
'soil'	the top layer of the Earth's crust situated between the bedrock and the surface. Soil is composed of mineral particles, organic matter, water, air and living organisms;	IED	Art. 3 (21)
'soil gas'	gas and vapour in the pore spaces of soils	ISO EN 11074	2.1.13
'unsaturated zone'	zone of the ground in which the pore space is not filled completely with liquid at the time of consideration	ISO EN 11074	3.2.8

<sup>5</sup> The choice of methods might be constrained by a variety of site-specific factors such as topography, geology, hydrogeology, propensity to flood, and climate

# TABLE OF CONTENTS

---

<b>1</b>	<b>INTRODUCTION</b>	<b>10</b>
1.1	Soil Washing background	10
1.2	Soil Washing applicability	11
1.3	Soil Washing implementation	12
<b>2</b>	<b>DESCRIPTION OF THE TECHNIQUE</b>	<b>13</b>
2.1	Scope	13
2.2	Soil washing facility	14
2.3	Wastewater treatment and recirculation	16
<b>3</b>	<b>FEASIBILITY STUDY</b>	<b>18</b>
3.1	Advantages and Limitations of Soil Washing	18
3.1.1	Advantages of Soil Washing	18
3.1.2	Limitations of Soil Washing	19
3.2	The Feasibility Stages/Sections of Soil Washing	19
3.2.1	Data Requirement	19
3.2.2	Treatable Contaminants	20
3.2.3	Treatable Matrices	21
3.2.4	Regulatory Requirements	21
<b>4</b>	<b>IN FIELD TEST</b>	<b>22</b>
4.1	Treatability Studies	22
4.1.1	Dekstop Assessment	23
4.1.2	Bench Testing	23
4.1.3	Pilot Trial	24
4.1.4	Process of Treatability Testing in Evaluating a Remedy	24
4.1.5	Process of Treatability Testing in Evaluating a Remedy	27
<b>5</b>	<b>MONITORING OF THE PERFORMANCE</b>	<b>27</b>
5.1	Introduction	27
5.2	Performance report	27
5.3	Types of monitoring	28
5.3.1	Operational -technological phase	28
5.3.2	Confirmation of the clean-up and post-remediation	29
5.4	Quality Assessment and Quality Control	29
<b>6</b>	<b>CONCLUSIONS</b>	<b>31</b>
	<b>REFERENCES</b>	<b>33</b>





## 1 INTRODUCTION

IMPEL, the European Union Network for the Implementation and Enforcement of Environmental Law developed, under the Water and Land Remediation (WLR) project, a series of guidelines focusing on the most common and most used soil and groundwater remediation technologies. These guidelines summarize the latest and most updated information on these remediation technologies that could help the distinct stakeholders such as site owners, surrounding community, project managers, contractors, regulators, and other practitioners to understand all the information emanating from each remediation project. It uses information supplied from the involved contributors, obtained in peer-reviewed scientific sources and official reports.

This guideline compiles the most recent knowledge on one of the most used remediation technologies, i.e., Soil Washing (SW).

### 1.1 Soil Washing background

SW is a water-based process for treating soils physically (and chemical) to remove unwanted contaminants and can be considered a widely used remediation technology at large contaminated sites. When removal of inorganic compounds from the treated material is not effective, pH conditioners (strong acids and bases, typically HCl and NaOH) can be added to the water.

In northern Italy, this technology has been applied in important areas such as the Milan Santa Giulia site and the sites of national interest in Sesto San Giovanni (Acciaierie Falck) and Brescia (Caffaro plant).

The term SW is more properly used to refer to treatment operations using water that occur on excavated soil and can be carried out *ex-situ*. In contrast, the term Soil Flushing (SF) (or soil leaching) indicates the extraction of contaminants from the soil with water or other suitable aqueous solutions *in-situ*.

The **Soil Flushing** process involves passing clean water or an aqueous solution through in-place soils (using infiltration or injection) and extracting the fluid from the underlying aquifer for a potential recovery.

Contrary, Soil Washing process removes contaminants from soils in one or both of the following two ways:

- By dissolving or suspending them in the wash solution (which can be sustained by chemical manipulation of pH for a period of time) – “Chemical” SW;
- By concentrating them into a smaller volume of soil through particle size separation, gravity separation, and attrition scrubbing - “Physical” SW.

During SW, contaminants tend to bind, chemically or physically, to silt and clay, and soil organic matter. Silt and clay, in turn, bind to sand and gravel particles. The soil washing process separates the contaminated fine soil (silt and clay) from the coarse soil (sand and gravel). When completed, the smaller volume of soil, which contains the majority of the fine silt and clay particles, can be further treated or disposed of according to national regulations. The clean fraction of soil obtained from SW treatment can be reused on-site, e.g., for excavation fills, only if it meets the standards required by regulations. In fact, the main objectives of treatment by SW are to reduce the volume of contaminated soil for any further waste management (e.g. high temperature incineration or disposal at landfills) and to recover secondary raw materials. During SW treatment, the homogenization of soil allows optimizing the contact between extracting agents and soil pollutants. Thus, the treatment efficiency is more easily monitored and the contact time is reduced during SW compared to SF.

A typical SW plant is presented in figure 1.1. The plant is composed of a few modular components, transportable and positionable on flat waterproofed ground (figure 1.2).

In this iteration, the plant units consist of an elevated loading hopper, conveyor belts (figure 1.3) followed by a series of wet screens capable of sorting different cuts of sand and gravel, a drum wash, a series of hydrocyclones, and the water treatment circuit with two filter presses for sludge extraction. It should be noted, however, that alternative technologies exist for each of these steps, and that the technologies and configuration of a SW plant will be determined based on the physical and chemical characteristics of the soils and the specific contaminant(s) at a given site."

## 1.2 Soil Washing applicability

The method is particularly efficient in treating soils containing predominantly coarse fractions such as gravels, sands and pebbles and is relatively less efficient when finer fractions such as silt, clay and/or soil OM prevail (soils with higher hydraulic conductivities work best). This technique has a low efficiency if the contaminants adsorb strongly onto the soil particles, due to the fact that this process is not always able to fully remove the contaminants from the soil surface.

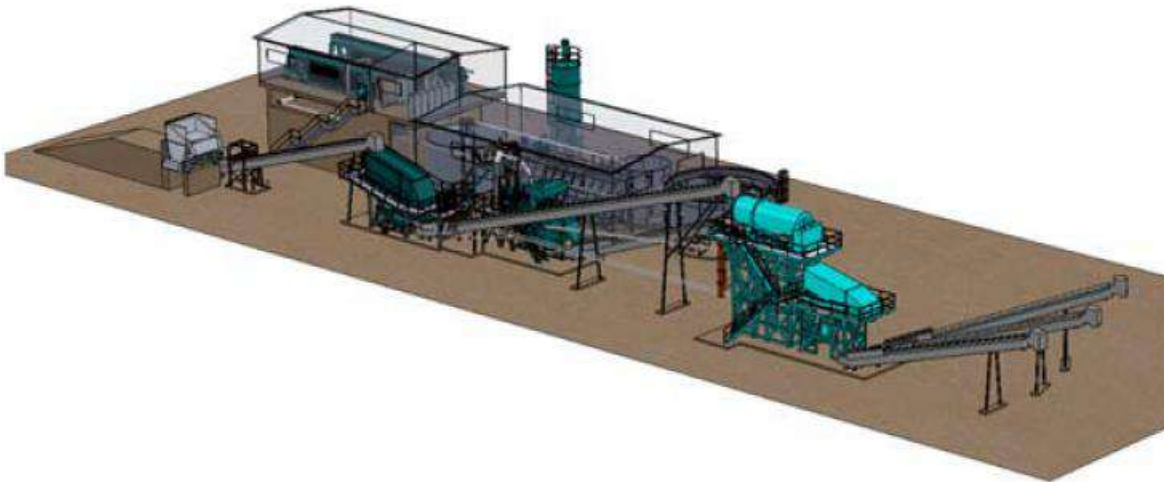

Figure 1.1- Soil Washing plant.



Figure 1.2- Contaminated soil loading area



Figure 1.3 - Soil washing stage conveyor belt

Considering the type of contaminants, SW may be used to treat soils containing a wide variety of organic and inorganic contaminants including petroleum-derived hydrocarbons, heavy metals, PCBs, phytochemicals, polycyclic aromatic hydrocarbons, selected VOCs, pesticides, cyanides.

However, there is a series of factors that may limit the applicability and the effectiveness of the SW process that may include:

- Complex contamination patterns (e.g., metals with organics), which make the selection of an appropriate washing fluid difficult.
- High humic content in soil may require pretreatment.
- 
- It may be difficult to remove organics adsorbed onto clay-size particles.

Soil washing can be especially viable to treat contaminated soils associated with large-scale construction projects, where the costs of soil excavation are already included in the project, and where clean soil fractions get reused on site to provide construction aggregate for the project.

### 1.3 Soil Washing implementation

Soil washing is generally considered a media transfer method. The contaminated waters generated from soil washing are treated with the technology(s) suitable for the contaminants.

The duration of soil washing is typically short- to medium-term

The implementation of Soil Washing treatment can involve the following steps:

- excavation and temporary storage of the contaminated soil;
- pre-treatment by screening the soil to remove coarse elements and anthropogenic materials;
- washing the soil with water or an aqueous solution to separate the fraction with contaminants;
- treatment of wash water;
- recovery of the coarse fraction in situ for fill and environmental remodelling.

Those steps are schematically presented in Figure 1.4.

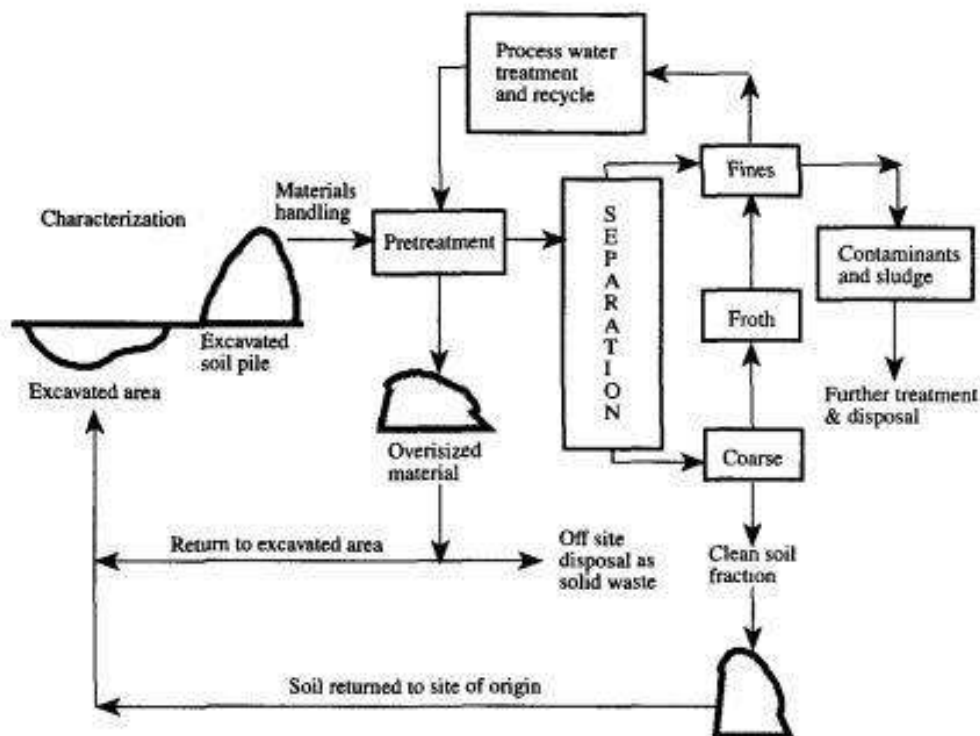

Figure 1.4. Schematic SW process (from US EPA 1996)

## 2 DESCRIPTION OF THE TECHNIQUE

### 2.1 Scope

Soil Washing (SW) is a relatively simple method that essentially involves separating the fine from the coarse fraction of contaminated soil material using water or aqueous solutions. Nevertheless, to optimise the efficiency of soil washing systems processes can be designed and tailored taking account of a specific contaminant mixture and soil type.

Basically, soil washing focuses on a volumetric reduction of the excavated mass of contaminated soil through a separation of the fine fraction (in which pollutants are concentrated) from the coarser fraction that can be recovered.

Through separation and removal of the contaminated fine fraction, the remaining coarse fraction, if it meets the standards required by current regulations, can be:

- recovered and used for backfilling of remediation excavations;
- reused for fill, embankments or subgrades at other sites;
- recovered for morphological restoration of quarried areas.

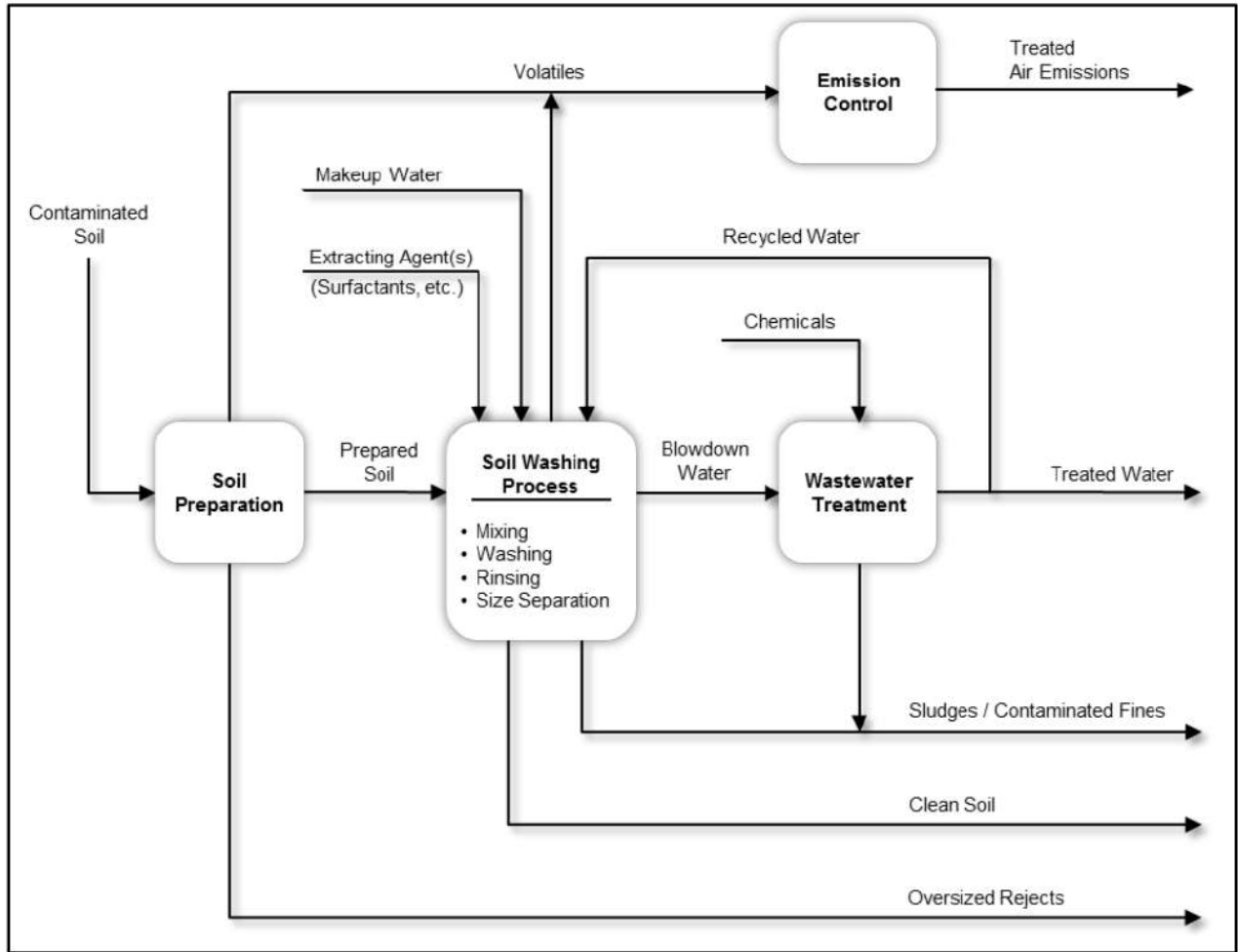

▪ Figure 2.1- Soil washing process diagram (CRC CARE National Remediation Framework, 2018 – [2])

Soil washing treatment is usually done *ex-situ*. The equipment used is standard mineral processing equipment, which is more generally used in the mining industry.

## 2.2 Soil washing facility

The soil washing facility may normally enable the following stages: soil preparation and pre-screening, physical separation (mechanical screening, hydrodynamic classification, gravity concentration, froth flotation, magnetic separation, electrostatic separation, attrition scrubbing, etc.), chemical separation, soil washing (to remove the extraction agents) and wastewater treatment.

A typical SW facility consists of different parts, that relate to the following processes:

- **Soil preparation and pre-screening:** this process comprises mechanical screening to remove large materials ( $\phi > 50$  mm), such as construction debris, pieces of rock, and pebbles by a vibrating screen

equipped with an iron remover. These materials are generally not contaminated and are therefore sent to the crushing section for recovery on site.

- **Aggregate scrubbing:** the material is loaded at the lower end of an inclined tank, and it is transported to the upper end by two rotating shafts, equipped with blades to facilitate its disintegration. Silt and clay are removed by the water added to the top of the tank. Impurities and light substances flow out with the water at the lower end of the tank. The pH of the water can be modified to facilitate the solubilization of inorganic compounds, mainly metals.
- **Screening:** the coarse material ( $2 \text{ mm} < \emptyset < 50 \text{ mm}$ ) passes from the top of the scrubber onto a vibrating screener which separates the residual fine material. The coarse material is then further washed to remove the last fine fractions ( $\emptyset < 2 \text{ mm}$ , sand, silt, clay) and it accumulates at the base of the vibrating screener.
- **Sand recovery:** the water containing the fine material is collected in a tank downstream of the vibrating screener, and then it is pumped into a hydrocyclone. In the hydrocyclone, the centrifugal force separates the water with silt and clay from the sand; the water with silt and clay flow upwards of the hydrocyclone, while the sand comes out from the bottom of it. The wet sand passes through a dispenser that corrects the density of the mixture (60% - 80% of solids) and enters the attrition cells. These cells, thanks to the mixing blades, remove the clay particles and any contaminants on the sand particles. The sands coming from the attrition cells are dried with a vibro dryer. The dry sand mixed with the treated coarse material is transported to the storage platforms.
- **Wastewater treatment:** the SW plant can typically process up to about 200 t/h of soil material. Washing is usually done with water only; however, if the removal of inorganic compounds from the treated soil material is not effective, pH conditioners (strong acids and bases, typically HCl and NaOH) can be added.

To complete the plant, there is usually a section for mechanical dewatering of the sludge produced (fine fraction) and a section for treatment and recirculation of washing water. Water quality management during processing is very important, as water is recycled. Efficient water management not only reduces the overall amount of water used during processing, but also ensures that any contaminants that are transferred into the water during processing do not re-contaminate clean products. [1]





Figure 2.2- Soil washing process (photos by Massimiliano Confalonieri)

Full-scale soil washing plants can be either portable units or a fixed soil washing facility. A portable unit can process soil on the contaminated site, saving the cost of transporting the soil to the nearest fixed plant. However, there can be large costs and preparation times associated with obtaining the necessary regulatory approvals and mobilizing and demobilizing a portable plant, and this can make a portable plant less preferred unless large volumes of soil need to be treated.

### 2.3 Wastewater treatment and recirculation

Wastewater treatment and recirculation sections play an important role in SW treatment and may include components such as:

- **sedimenter (or clarifier)**: in which the separation between the sludge and the clear supernatant water takes place. Upstream of the sedimenter the appropriate treatments with dosage of chemicals for water purification will be carried out;
- **de-oiling tank**: for separation of suspended organic contaminants from the supernatant waters leaving the sedimenter;
- **chemical-physical treatment plant**: for purification of water leaving the de-oiling unit;



- **quartzite, activated carbon or ion-exchange filtration section:** for water leaving the chemical-physical plant;
- **storage tank:** in which the water following treatment will be stored for reuse within the soil washing plant;
- **homogenization (or thickener) tank:** in which the sludge coming out of the sedimenter will be homogenized;
- **plate filter press (or press):** in which further separation of solids from liquids will take place, concentrating the pollutants in the panel and reducing the relative humidity to the lowest attainable value.



Figure 2.3- Areal view of the soil washing plant (front), sludge treatment facility (left hand side) and the reception hall (in the back).  
Copyright: ARGE AUDI IN-Campus GbR (ask for permission to Dr. Benjamin Faigle – Züblin Umwelttechnik GmbH)

### 3 FEASIBILITY STUDY

Soil Washing is a physical or chemical technology that separates contaminated and non-contaminated soil components by exploiting physical differences between them, such as particle size, shape, density and / or surface properties. Following Soil Washing, the contamination is concentrated into a smaller fraction of the total volume of impacted soil or sediment (generally in the fine fraction) which can be more easily disposed of or treated further (e.g. by solidification or stabilisation). The 'clean' fraction of the treated soil, comprising larger particles such as sand and gravel, is then able to be re-used separately, such as on-site (providing the concentrations meet the remediation criteria).

Soil Washing is considered feasible for the treatment of a wide range of inorganic and organic contaminants including heavy metals, radionuclides, explosives, cyanides, polycyclic aromatic compounds, pesticides, PCBs, and PFAS.

There are many factors that should be considered in the selection of Soil Washing as a remedy for contaminated soil. Key considerations that will often determine the feasibility of applying Soil Washing systems as a potential remediation option include:

- Whether the contaminated material has a significant percentage of coarse material that can be separated as a clean fraction suitable for reuse or lower cost disposal.
- Whether the separated fine contaminated material (slurry) can be dewatered and disposed of.
- Whether the relative volumes and costs for disposal of the resulting coarse or clean fraction and the fine or contaminated fraction makes the process economic.
- Will the relevant regulatory agencies accept Soil Washing as a viable means of remediation?
- Can the treated material be reused? Will the concentrations of inorganics and residual organics allow the treated material to be reused as backfill on the site or as clean fill elsewhere, or will subsequent treatment (e.g. stabilisation) or landfill disposal be required?
- Is it likely that other stakeholders (such as local government or members of the public) will accept the use of the technology, particularly those stakeholders that can have a significant bearing on whether the technology is applied at the site? Are there sensitive sites nearby that would not be compatible with the proposed operation?
- Is there a time constraint, and can the application of Soil Washing meet this constraint?
- Is the expected order of cost of treatment acceptable?

Section 3.1 presents a brief summary of some advantages and limitations of the Soil Washing technology. This is not a complete listing of all pertinent technology factors, but is meant to provide a capsule overview of some of the key factors to be considered. Section 3.2 continues the stages of feasibility such as data requirement, physical properties and chemical composition of soil,

#### 3.1 Advantages and Limitations of Soil Washing

##### 3.1.1 Advantages of Soil Washing

- Soil Washing can treat both organics and inorganics in the same treatment system.
- Generally, there are no air or wastewater discharges from the system, making permit processes easier than for many treatment systems. This attribute should also make the technology attractive to local community stakeholders.

- Soil Washing is one of the few permanent treatment alternatives for soils contaminated with metals and radionuclides. Soil washing, which uses physical or chemical processes, is one of the few permanent treatment alternatives to separate the metals from soils [3].
- Most Soil Washing technologies can treat a broad range of influent contaminant concentrations.
- Depending upon soil matrix characteristics, Soil Washing can allow for the return of clean coarse fractions of soils to the site at a low cost [4].

### 3.1.2 Limitations of Soil Washing

- After treatment, there is a (relatively small) volume of contaminated solid media and wash water that must be further treated or disposed.
- Soil Washing may not be cost effective for soils with silt/clay content in excess of 30 to 50 percent (see Section 3 for more details).
- High humic content in the soil, complex mixtures of contaminants, and highly variable influent contaminant concentrations can complicate the treatment process.
- As for any ex-situ technology, there are space requirements for the treatment system. [4].

## 3.2 The Feasibility Stages/Sections of Soil Washing

### 3.2.1 Data Requirement

Successful implementation and design of a Soil Washing remediation program is dependent upon the following key technical characteristics:

- The physical properties of the soil to be treated.
- The chemical composition of the soil to be treated.
- The chemistry and concentrations of contaminants.

There are some key data requirements to initially assess whether Soil Washing may be a viable treatment option. These include:

- Particle size distribution (0.24 to 2 mm is the optimum range, and there should not be a large fraction of clay or silt).
- Soil type (coarse grained materials best suited).
- Physical form / particulate shape.
- Handling properties and moisture content.
- Contaminant type(s) and concentration(s).
- Texture.
- Organic content.
- Cation exchange capacity.
- pH.
- Buffering capacity.

#### 3.2.1.1 Physical Properties of Soil

The physical composition of the material to be treated needs to be well characterised. Important factors include:

- Soil particle size and its variability needs to be characterised: coarse material (gravel or sand) is likely to be most amenable to Soil Washing with the finer fraction separated during the process and likely to require additional treatment.
- Soil heterogeneity: differing grain sizes and the presence of larger lumps of material (such as masonry in fill) can affect the distribution of the wash water in the contaminated soil.
- The permeability and plasticity of the material, which can also affect the distribution of wash water in the contaminated soil.
- Water content, which may be high if soil from below the water table (or sediment in a surface water body) is to be treated.

Further factors to understand the physical properties of soil well are the silt/clay-ratio (depending on the contaminants silts might be treatable) and clay mineralogy (especially the presence of shrink/swell clays).

### 3.2.1.2 Chemical Composition of Soil

The composition of the material to be treated needs to be well characterised. Important factors include:

- The distribution concentrations and mass of contaminants in soils at the site, and the requirement to locate and treat contamination that exceeds certain concentrations, noting that contamination may be irregular in extent and location.
- The maximum allowable concentration and variation in concentration of the contaminants in the treated soil. If very stringent remediation criteria are applicable, then several rounds of washing may be required, or a higher volume may need further treatment or removal from the site.
- Humic acids and organic material. Contaminants tend to sorb to organic particles so if the soil has a high organic content, it is likely to be less receptive to being treatable by washing.
- Maximum allowable concentrations and forms of miscellaneous material such as plastic lining systems, steel, rock or asbestos, and the requirement for exclusion of unacceptable material. Soils are generally screened prior to washing to remove oversize or deleterious material prior to treatment.
- Salt content, such as can occur if sediments in saline water are to be washed, and whether the resulting saline waste stream can be disposed of.

### 3.2.1.3 Waste Streams

Once the soil has been washed, there will be waste streams generated by the process that will need further treatment and/or disposal, including for example:

- Oversized material rejected during pre-screening.
- Treated material (that does not meet the remediation criteria).
- Fine fraction material containing higher concentrations of contaminants and water.
- Spent media from water treatment systems
- Used Personal Protective equipment and associated consumables.

## 3.2.2 Treatable Contaminants

Soil Washing is most commonly used to treat:

- coarse fraction material containing higher concentrations of contaminants and water.
- Used PPE and associated consumables.
- Heavy metals.
- Petroleum hydrocarbons.
- Some volatile organic compounds. [5]

However, dependent on site conditions and soil types (see also chapter 4) it can also be effective at treating the following contaminants:

- Polychlorinated biphenyls.
- Polycyclic aromatic hydrocarbons.
- Acids.
- Explosives
- Radionuclides Pesticides and herbicides.
- Cyanides. [6]
- PFAS. [7]

### 3.2.3 Treatable Matrices

Soil Washing is most suitable for treatment of coarse grained or sandy soils that have clay and silt content less than approximately 30% of the soil. Soils with a more dominant fine fraction may be suitable to be remediated using this method, however, it is likely that significant volumes of waste material will need to be disposed of or require further treatment after completion of the process, which can reduce cost effectiveness. [7]

Soil Washing via chemical extraction, in comparison, may not be subject to such matrix constraints, as the contaminants may be able to be leached from relatively fine material.

### 3.2.4 Regulatory Requirements

Regulatory agencies, particularly those responsible for protection of the environment, town planning, and licensing treatment facilities should be consulted to determine the specific requirements relating to obtaining the necessary approvals, permits and licences, and controls that can be expected, prior to conducting the Soil Washing remediation program [8]

## 4 IN FIELD TEST

Soil Washing is a physical and chemical technology that separates contaminated and non-contaminated soil components by exploiting physical differences between them, such as particle size, shape, density and / or surface properties.

There are four main stages in applying Soil Washing as a treatment technology:

- Soil preparation and screening.
- Physical separation.
- Chemical extraction.
- Waste water treatment.[3]

Soil Washing is rarely a stand-alone treatment technology, as the fine soils and waste water will generally require additional treatment following completion of the washing process. While the waste water is generally treated using standard industry practices, the sludge generated during the waste water treatment may require treatment by an alternative remediation technology such as solidification/stabilisation, bioremediation, chemical treatment (e.g. the base catalysed decomposition process) or thermal treatment. Figure 2.1 provides a flow diagram of the Soil Washing process

### 4.1 Treatability Studies

Soil Washing is a volume reduction/waste minimisation treatment technology based on physical and/or chemical processes.

If there is uncertainty as to whether Soil Washing will achieve the desired outcome in terms of treated soil, or there are other issues that make it uncertain as to whether Soil Washing will be effective, it may be necessary to conduct treatability pilot studies to investigate the application and results of Soil Washing in the conditions prevailing at the site to be remediated.

Designing the treatability study may require input from several technical specialists including environmental specialists, chemical engineers, mechanical engineers and air quality specialists to ensure that the study is targeted to obtain the data required to develop an appropriate implementation strategy.

The additional information required may be determined by reviewing the published literature and information on case studies on the application of Soil Washing.

There are generally three stages of testing that can be undertaken:

- **Desktop assessment:** to determine whether Soil Washing is a viable treatment solution for the specific site.
- **Bench testing:** to assess the effectiveness of Soil Washing for the specific site conditions and contaminant concentrations. In general bench testing allows for selecting suitable system components, tailor the system configuration and extraction additives. Accordingly, the Remediation Action Plan usually can be designed and written upon completion of this stage.
- **Pilot trial:** to determine specific operating parameters and performance criteria and provide sufficient information to enable completion of the RAP.

- **Process of Treatability Testing in Evaluating a Remedy:** Treatability studies should be performed in a systematic fashion.

The data from each stage of treatability testing should be reviewed and interpreted jointly by the consultant and remediation contractor, with a projection being made of the results that will be achieved under full scale operation and requirements established for implementation [7]

#### 4.1.1 Desktop Assessment

The data from each stage of treatability testing should be reviewed and interpreted jointly by the consultant and remediation contractor, with a projection being made of the results that will be achieved under full scale operation and requirements established for implementation. Desktop assessment aims to broadly assess the applicability of Soil Washing to the general site conditions. In many cases, this stage may be preceded by some testing of discrete soil samples at the site assessment stage as a preliminary options screening, and as part of determining suitable materials for the treatability tests.

Soil washing feasibility is usually assessed based on a review of the data available from a previous contamination assessment where, for example, soil bore records document, the soil conditions beneath ground present at the site and analytical reports will detail the contaminant concentrations. The particle size distribution should be known and the constraints on disposal of the concentrated fine fraction are likely to be critical factors in determining whether Soil Washing will be feasible. However, where insufficient data are available to assess the potential for Soil Washing, tests can be undertaken at bench scale, using soil and wash water in jars. These preliminary tests can usually be completed within a few hours.

#### 4.1.2 Bench Testing

Bench testing aims to assess whether Soil Washing can meet the remediation objectives and its applicability to the specific waste type under the specific site conditions.

Soil washing bench testing generally comprises laboratory testing to enable a mass balance to be calculated and assess the contaminant concentrations in the washed soil. The results should allow an estimate of the quantity of soil that will be sufficiently treated that it meets the remediation objectives (i.e., the success rate for Soil Washing).

Likely data objectives for the second stage of treatability testing are:

- Assess what chemicals/reagents will be needed to treat the contaminants in the soil (e.g. acids or surfactants) which may impact the treatment requirements for the waste residue. Can they be treated?
- Assess contaminant concentrations in the clean soil fraction achieved following treatment (to determine whether the nominated remediation criteria can be met), and the percentage of the soil that meets the remediation objectives.
- Assess contaminant concentrations in the concentrated waste soil fraction following treatment (to determine the requirements for dewatering and disposal or treatment). The variability in contaminant concentrations needs to be considered, as Soil Washing will result in increased concentrations in the waste material. Will Soil Washing be cost effective?

- What is the likely water balance – the extent to which water can be recycled and make up is required? Will there be a build-up of soluble salts in recycled water? What is likely to be the most effective soil: wash water ratio?

Bench testing is more expensive than a desktop assessment and generally takes several weeks to plan and implement. These tests have the objective of more closely replicating the physical and chemical parameters of the site under investigation. The information obtained in the second stage of testing is usually sufficient to enable development of the Remediation Action Plan [5]

TABLE 2-1. Physical Prescreening Soil Characterization Tests

Parameter	Description of Tests	Standard Analytical Method	Reference
Grain size analysis/ particle size distribution	Sieve screening using #10 and #60 screens or equivalent & Sedimentation (Hydrometer) Analysis	ASTM D422 ASTM D7928	4
Cation exchange capacity (CEC)	Ammonium acetate Sodium acetate	Method 9080 Method 9081	5,6

#### 4.1.3 Pilot Trial

If insufficient data was obtained during bench testing to design the RAP, a third stage of treatability testing can be undertaken to obtain information necessary for the design of the Soil Washing remediation program, specific to the conditions of the site.

Field trials usually comprise a small-scale test of the full remediation program. A large volume of the soil to be remediated may be taken to a Soil Washing facility and put through the unit with various chemical mixtures to assess the Soil Washing efficiency under differing operating conditions.

The cost of this stage of testing is high (comparable to the full remediation program), so clear data objectives should be determined at the outset. On completion of this stage of treatability testing, it should be possible to establish the requirements for the full-scale implementation, the time scale for the completion of remedial works, and an improved estimate of the level of cost.

#### 4.1.4 Process of Treatability Testing in Evaluating a Remedy

Treatability studies should be performed in a systematic fashion to ensure that the data generated can support the remediation evaluation process. This section describes a general approach that should be followed by Remedial Program Managers and Potentially Responsible Parties, and contractors during all levels of treatability testing. This approach includes:



There are generally three stages of testing that can be undertaken:

#### Planning Stage

- Establishing data quality objectives.
- Selecting a contracting mechanism.
- Issuing the Work Assignment.
- Preparing the Work Plan.
- Preparing the Sampling and Analysis Plan.
- Preparing the Health and Safety Plan.

#### Execution

- Conducting community relations requirements.
- Complying with regulatory requirement.
- Executing the study.
- Data collection

#### Reporting

- Analyzing, validating and interpreting the data.
- Reporting the results.

Treatability studies for a particular site will often entail multiple tiers of testing. Efficiency can be increased by recognizing this possibility in the early planning phases of the project. The Work assignment, Work Plan, and other supporting documents should include all anticipated activities. There are three levels or tiers of treatability studies: remedy screening, remedy selection, and remedy design testing. Some or all of the levels may be needed on a case-by-case basis. The need for and the level of treatability testing required are management decisions in which the time and cost necessary to perform the testing are balanced against the risks inherent in the decision (e.g., selection of an inappropriate treatment alternative). These decisions are based on the quantity and perceived quality of data available and on other decision factors (e.g., State and community acceptance of the remedy or new site data). The flow diagram for the tiered approach in Figure 3-1 traces the stepwise review of data with the decision points and factors to be considered. Technologies generally are evaluated first at the remediation screening level and progress through remediation selection to the remedy design testing. A technology may enter the selection process, however, at whatever level is appropriate based on available data on the technology and site-specific factors. For example, a technology that has been successfully applied at a site with similar conditions and contaminants may not require remedy screening to determine whether it has the potential to work. Rather, it may go directly to remedy selection testing to verify that performance standards can be met and generate preliminary cost estimates. Treatability studies, at some level, will normally be needed to assure that the technology can achieve site target cleanup goals even if previous studies or actual implementation have encompassed similar site conditions. Figure 4-2 shows the relationship of the three levels of a treatability study to each other and to the Remedy Investigation/Feasibility Study process.

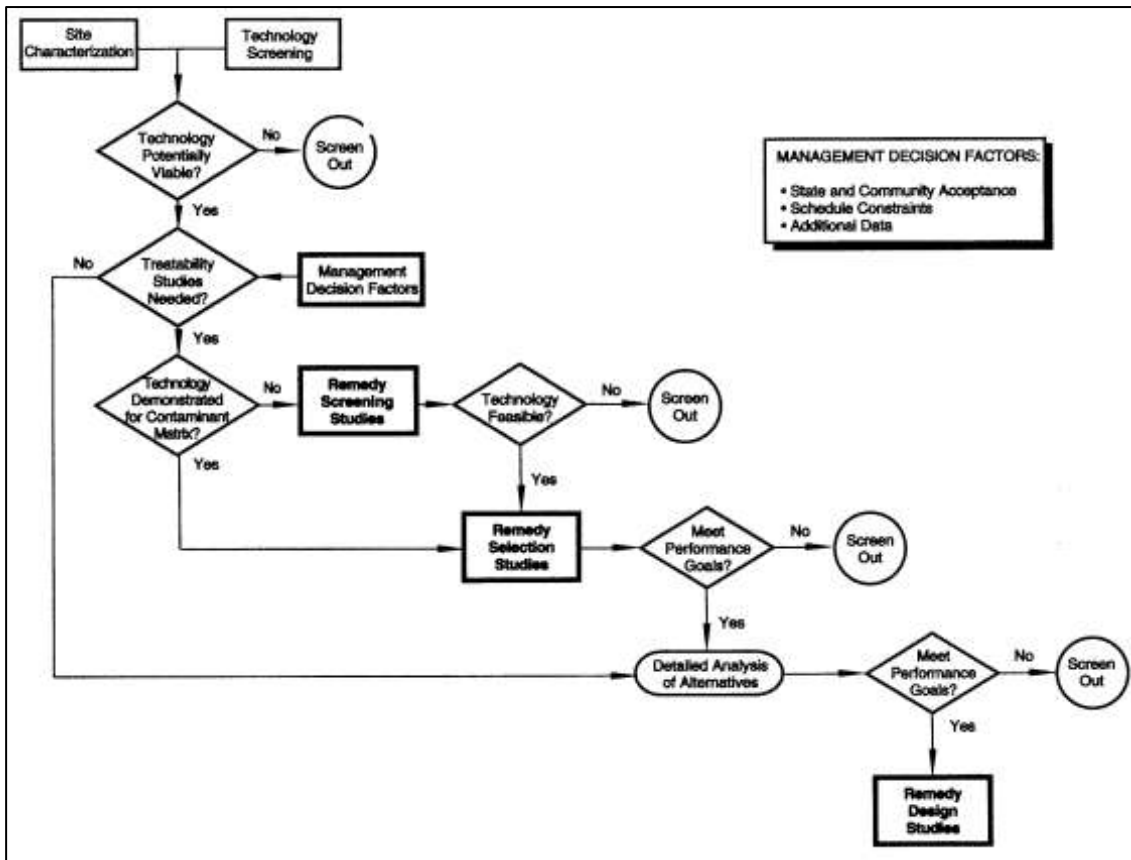

Figure 4.2- Soil washing flow diagram tiered approach

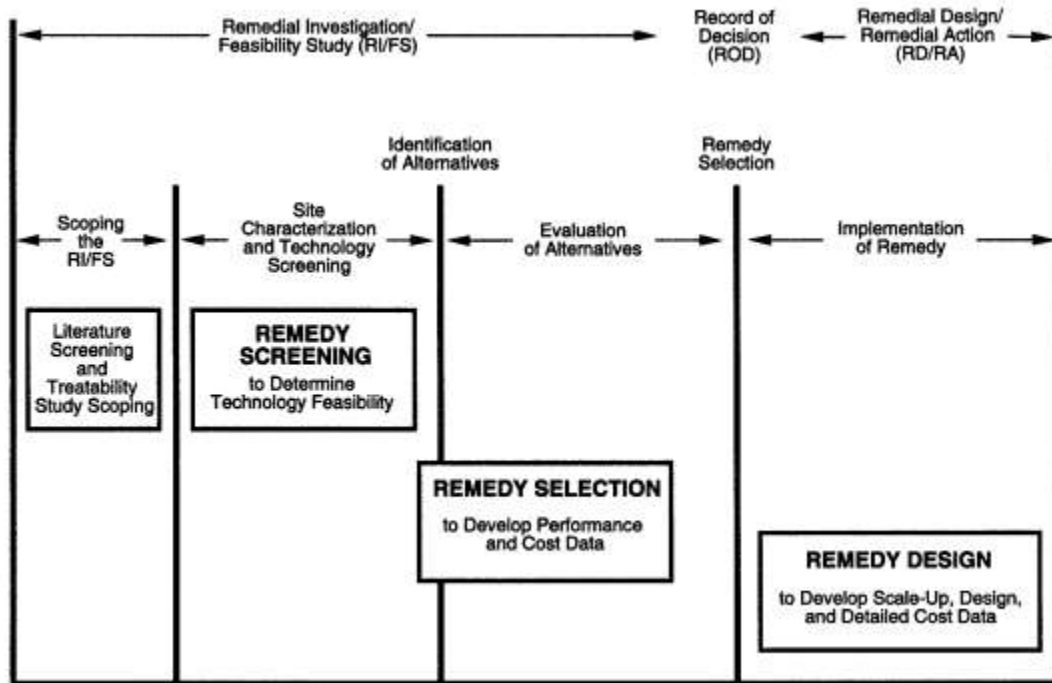

Figure 4.3- Soil washing the role of treatability studies. [12]

#### 4.1.5 Process of Treatability Testing in Evaluating a Remedy

Before conducting treatability studies, the objectives of each tier of testing must be established. Soil washing treatability study objectives are based on the specific needs of the Remedy Investigation/Feasibility Study. There are nine evaluation criteria specified in the document “Guidance for Conducting Remedial Investigations and Feasibility Studies Under CERCLA” (Interim Final);[12] the treatability studies provide data for up to seven of these criteria. These seven criteria are:

- Overall protection of human health and environment.
- Compliance with applicable or relevant and appropriate requirements Applicable or Relevant and Appropriate Requirements (ARARs).
- Reduction of toxicity, mobility, or volume through treatment.
- Short-term effectiveness.
- Implementability.
- Long-term effectiveness and permanence.
- Cost.

The first four of these evaluation criteria deal with the degree of contaminant reduction achieved by the Soil Washing process.

- What will be the remaining contaminant concentrations?
- Will the residual contaminant levels be sufficiently low to meet the established ARARs and the risk-based contaminant cleanup levels?
- What are the contaminant concentration and physical and chemical differences between the untreated and the washed soil fractions (i.e., has contaminant toxicity, mobility, and volume been reduced)? The fourth criterion, short-term effectiveness, addresses the risks posed by the treatment technology during construction and implementation of a remedy [6, 8].

## 5 Monitoring of the performance

### 5.1 Introduction

Soil washing is a short to medium term treatment technology (time frame between weeks to months) to treat the contaminated medium. The duration and effectiveness of treatment depends on the size of the system and the achievable throughput (processing) rates [13]. After site characterization and decision on the conditions to be applied, monitoring will assess remediation progress and support the decision to end the remediation as the clean-up criteria have been met.

### 5.2 Performance report

A cost and performance report describes the route and direction of the applied remediation technique, i.e., Soil Washing. In general, the report should contain site information, matrix description, treatment system description, treatment system performance, and treatment system costs [4]. Specifically, the treatment system performance should include [4]:

- cleanup goals / standards;
- treatment performance data (including sampling/analytical methods, sample frequency/location, test run data summary, full-scale sustained run data summary);
- performance data assessment;
- performance data completeness;
- performance data quality.

Soil washing is an aggressive ex-situ technology aimed at reducing the volume of contaminated excavated material that requires further treatment or disposal. The cost of soil washing depends on a number of factors, including the size of the equipment required, the desired concentration endpoints in the soil, the nature of contaminants, particle size distribution (particularly percentage of silt and clay), site preparation requirements, and volume of soil that needs treatment [13, 14]. A soil with a low percentage of silt and clay and washing solution without additives (only water) will increase the cost-effectiveness of the process.

### 5.3 Types of monitoring

The treatment performance should be assessed with an integrated approach. An advantage of Soil Washing is that the process is flexible and can be modified at different stages to maximize the efficiency. Although bench scale/treatability studies will be the starting point to design the Soil Washing process for a specific contaminated site, the performance of a continuous system may be more complex, thus requiring adjustments. The more detailed and structured the monitoring plan is, the greater the possibility of adjusting the approach and correcting problems during the process.

Before Soil Washing application, the parameters that can be assessed include [15]:

- contaminant types and concentrations;
- particle size distribution
- partitioning of contaminants between soil and washing solution;
- other chemical characteristics of soil (e.g. pH, concentrations of ions e.g., chloride, sodium, calcium, magnesium, sulphate, carbonate, iron, sulphide, etc.);
- cation exchange capacity of soil;
- buffering capacity for acids;
- organic matter content;
- mineralogy (especially: clay mineralogy);
- moisture content (initially affects the strength of the leachate);
- behaviour of contaminants at different pHs;
- redox potentials.

#### 5.3.1 Operational -technological phase

According to [14] the Waste Soil Characterization parameters include:

- Particle size distribution and cation exchange capacity;
- Type, physical form, handling properties and moisture content;
- Contaminants: organics and/or inorganics, including class, concentration, volatility, partition coefficient, humic acids;
- pH, buffering capacity.

An inaccurate site characterization may influence the process efficiency. If, for example, the soil on-site differs from the material tested in the treatability study/pilot scale, the proportion of the fine-grained fraction is different from the expected proportion, and there is a presence of additional contaminants [2]. Also the choice of the appropriate washing solution and its capacity to promote contaminant removal may highly influence process efficiency. If not chosen for the actual case, washing additives may interfere with the washing

treatment and increase process costs [14]. Despite the washing additives being designed for the site, soil and contaminant conditions (e.g., chelating agents, solvents, surfactants), the performance monitoring may need to adjust/redefine the optimum combination of the washing solution, aiming at solubilizing, mobilizing, precipitating and complexation the organic and/or inorganic chemical constituents [14]. So, changes in, e.g., contaminant and concentration in the feed matrix may influence the process efficiency requiring adjustments.

During operation and in scale-up conditions, cost and performance may be influenced by soil throughput, wash water usage, additive dose, nature and form of the contaminant in the fine fraction, cost of disposal or further treatment of the fine fraction, identification of contaminants and concentration in the wash water [14]. Also, the release of volatile organic contaminants (VOC) or chemical reactions of wash water additives and unidentified contaminants or the mineralogy of the material itself that may lead to fugitive emissions in full-scale operation [14] should be taken into consideration.

### 5.3.2 Confirmation of the clean-up and post-remediation

Remediation is effective when the pre-established cleanup goals / standards are met. In the specific case of Soil Washing, different streams should be considered: oversized materials, coarse granular materials (sands produced by treatment), the fine granular fraction containing the concentrated contaminants, and process water [14]. In streams with contaminants (e.g., the fine fraction), it should be decided that the need to be treated or disposed of according to pre-defined /regulatory parameters.

The washing solution may be recycled and reused in the Soil Washing process or be treated for discharge (with lower and higher quality requirements, respectively). Characteristics of the washing solution are the contaminant concentrations, presence of other elements/compounds, and matrix (e.g., salt content) and may contain some coarse-grained sands (with vestigial or absent contamination), fine-grained solids, organic humic compounds, dissolved salts (present in the original soil), changes in pH value, dissolved or solubilized heavy metals [14]. All this may affect the efficiency of the Soil Washing process and pose additional challenges to treat the washing solution, affecting the efficiency of its recycling or cleaning.

The fine fraction can be dewatered into a sludge cake for deposition or subject to further treatment (taking advantage of the reduction of the contaminated matrix, providing a cost-effective process as fewer residues needs to be treated compared with the total soil mass).

Treatability studies complemented with performance monitoring will help controlling the quantity of the final produced streams. For example, if the washing solution has limitations in promoting contaminant removal, multiple wash cycles will be required leading to a larger volume to treat. If a soil has a more dominant fine fraction, higher volumes of waste material will need to be disposed of or have to be further treated.

After treatment, pre-determined requirements should be applied to support the decision on the destination of the treated material (coarse fraction), e.g., re-used as backfill on the site, clean fill in another location, or undergo another remediation step.

## 5.4 Quality Assessment and Quality Control

Quality Assessment and Quality Control (QA/QC) should be applied in operations such as the design of the Soil Washing approach, process control procedures, adjustment of system performance, and sampling and analysis procedures [15].

The QA/QC program should take in consideration at least following points:

- Responsibility; everybody from top management to the individuals participating in every phase of work are involved in quality assurance.
- Training and Certification; only proper training and certification can ensure that collected data is taken and interpreted correctly.
- Documentation; SOP for collecting and interpreting data must be developed and used.
- Instrument calibration; to ensure appropriate data collection and intra- and inter laboratory comparability, instrument calibration standards and procedures are inevitable [16].

QA/QC samples should provide information on the variability and usability of operational results (please see previous sections).

In the laboratory, QA/QC should account for field replicates, performance evaluation samples, matrix spike samples, background samples, or other QA/QC samples when appropriate (e.g., rinsate blanks, trip blanks). The types and numbers of QA/QC samples needed to get insight into the error and confidence in the data relates to the sampling objectives (e.g., site monitoring or remediation endpoint) and the corresponding QA/QC objectives.

The QA/QC laboratory program is therefore a critical part of the management system that should be used to prevent, detect and correct problems in the measurement process and/or to demonstrate achievement of statistical control. The aim of the QA/QC program is to limit errors in analytical measurements to a level acceptable to the data user and to ensure that the analytical results have a high probability of being of acceptable quality.

The main key steps in establishing QA/QC are:

- planning to define acceptable error rates;
- Quality control to establish error rates at acceptable levels;
- quality assessment to verify that the analytical process is operating within acceptable limits;
- Reporting and auditing data quality within the laboratory [16].

## 6 Conclusions

Soil washing is a downstream waste treatment method applied after excavation of contaminated soil material. Its application is determined by the granulometry of the excavated material, the type of contaminants and their distribution in the various grain fractions.

Soil washing can be performed either on-site for larger construction and remediation projects or ex-situ at existing soil washing facilities for smaller or more complex cases. For on-site plants treating large excavation volumes and performing a high recovery of recyclable aggregates, transport volumes can be reduced, thus improving the life cycle assessment of the operation.

Soil washing aims to fractionate and clean the contaminated excavated material in order to obtain recyclable aggregates and/or to be able to dispose of fractions in less expensive disposal channels. In general, soil washing can remove pollutants from the coarse-grained fractions or at least reduce their pollution, which results in the accumulation of pollutants in the process water and/or in the fine-grained fractions (sludge).

Depending on waste legislation, pollutant immobilization steps can be added after the soil washing process in order to be able to achieve the disposal limits for waste dumps.

Soil washing is rarely the only waste disposal method, since partial waste streams usually end up in further disposal facilities (such as thermal soil treatment plants or landfills) either directly or as a residue from soil washing. The legally compliant disposal of these waste streams is a mandatory part of the successful disposal and treatment via a soil washing facility.

The key factors that determine the effectiveness of Soil Washing are:

- Pollution distribution over the different granulometry range of the waste: the greater the proportion of gravel and sand, the more suitable the contaminated excavated material is for soil washing. By means of wet mechanical processes, the coarse fractions can be liberated from most of the pollutants. These coarse fractions can then be recycled as building materials. The fine fractions silt and clay are separated in the soil washing process by sedimentation and then dewatered with filter presses. These fractions usually have high pollutant content. In case of organic pollutants, a thermal treatment of the fine fraction or the use as alternative raw material in the cement industry allows for the mineralization of the pollutants. In the presence of relevant nonorganic pollutants, an immobilization prior to the disposal in an appropriate landfill may be necessary.
- Pollution by pollutants as particles: The particles causing the pollution should have physical properties as different as possible from those of the soil matrix. This ensures a sharp separation by the wet mechanical process. A treatment by soil washing becomes more complex, if the foreign particles have similar properties to those of the soil matrix or form conglomerates with the latter that are difficult to disperse. For soil washing to be successful, the pollutants should be solubilized or transferred to the fine fraction as completely as possible. This process can be supported using additives. If the pollutants adhere to the coarse grain fraction or have even diffused into it, soil washing might not be the right choice.

The main advantages are:

- If the above-mentioned requirements for soil washing are fulfilled, the washed coarse fractions can almost entirely be recycled;

- The reduction of waste to be landfilled or thermally treated and the recycling of the cleaned fraction usually result in a good eco-balance for the soil-washing process.
- With on-site plants transport can be massively reduced, which, depending on the energy required to build the on-site plant, can also have a positive effect on the eco-balance of the remediation measure.
- Thanks to the flexible processing technology and a wide range of additives, a wide range and mixtures of pollutants can be treated.
- Closed loops in water treatment and recycling may minimize water consumption.

Disadvantages and limitations are:

- Soil-washing is not a remediation technology as such, but a treatment method. This means that the waste must be excavated and then washed in an on-site or ex-situ facility.
- Soil washing is not recommended for mainly fine-grained excavated materials, since these can hardly be depleted from the contaminants and only low recyclable fractions will result. One exception is fine-grained material contaminated with Cr-VI.
- During soil washing, the pollutants accumulate in the fine-grained fractions, which usually must be disposed of at high cost in thermal desorption plants or landfills.

In summary, soil washing is an effective waste treatment method to clean coarse-grained excavated material from polluting particles and pollutants in order to be able to recycle the coarse fractions (gravel and sand) generally without restrictions.

Although a relatively straightforward treatment process successful projects and treatment facilities require broad expert knowledge and experiences. Effectiveness and efficiency are dependent on a sound understanding of the various mineral processing equipment components, process technology design, soil science, and the characteristics of the contaminant(s) to be treated.



## REFERENCES

- [1] Understanding Soil Washing, September 2007, CLAIRE Technical Bulletin, TB
- [2] CRC for Contamination Assessment and Remediation of the Environment, 2018, National Remediation Framework - Technology guide: Soil washing,
- [3] DERMONT, BERGERON, MERCIER & RICHER-LAFLECHE, 2008, Soil washing for metal removal: A review of physical/chemical technologies and field applications, *Journal of Hazardous Materials*, Vol. 152(1), pp 1-31.
- [4] Technical and Regulatory Guidelines for Soil Washing, Interstate Technology and Regulatory Cooperation Work Group Metals in Soils Work Team Soil Washing Project, 1997 USA
- [5] FRTR, 2014, *Remediation technologies screening matrix and reference guide (V4): Issue 4.19 Soil Washing* [Online]: United States Federal Remediation Technologies Roundtable. Available: <https://frtr.gov/matrix2/section4/4-19.html> [Accessed 10 June 2014].
- [6] US DOD, 2013, *United Facilities Guide Specification: Soil washing through separation/solubilization*, UFGS-02-54-23, United States Department of Defence, Washington, DC.
- [7] QUINNAN, MORELL, NAGLE & MAYNARD, 2022, Ex situ soil washing to remove PFAS adsorbed to soils from source zones, *Remediation –The Journal of Environmental Clean Up Costs, Technologies, & Techniques*, Vol. 32(3), pp 151-166. [8] US EPA, 1991, *Guide for conducting treatability studies under CERCLA: Soil washing (interim guidance)*, EPA/540/2-91/020A, United States Environmental Protection Agency, Cincinnati, OH.
- [9] [https://www.qu.edu.qa/static\\_file/qu/colleges/engineering/civil/documents/Lab%20Manuals/Geotechnical\\_Laboratory\\_Manual.pdf](https://www.qu.edu.qa/static_file/qu/colleges/engineering/civil/documents/Lab%20Manuals/Geotechnical_Laboratory_Manual.pdf)
- [10] <https://www.epa.gov/sites/default/files/2015-12/documents/9080.pdf>
- [11] <https://www.epa.gov/sites/default/files/2015-12/documents/9081.pdf>
- [12] US EPA, 1993, Innovative Site Remediation Technology Soil Washing/Soil Flushing Volume 3, EPA/542/B-93/012
- [13] USEPA. 1996b. Soil Screening Guidance: Technical Background Document. Office of Emergency and Remedial Response, Washington, DC. EPA/540/R95/128USEPA. (1993).
- [14] Innovative Site Remediation Technology, Vol 3: Soil Washing/Soil Flushing. 1993. *United States Environmental Protection Agency*. Ed. William C. Anderson, 1993.
- [15] Remedial Treatment for Contaminated Land, Vol IX: In-situ methods of remediation. *Construction Industry Research and Information Association*. Special Publication 109, 1995.
- [16] Innovative Site Remediation Technology, Design and Application, Volume 3, Liquid Extraction Technologies, Soil Washing, Soil Flushing, Solvent/Chemical, US EPA, 1998.



European Union Network for the Implementation  
and Enforcement of Environmental Law

# Annex 1

---

## Soil Washing – Case studies

IMPEL Project no. 2021 /08 WG6



## 1. Your contact details - CASE STUDY: SW n.1

<b>1.1. Name and Surname</b>	Alessandro Teani
<b>1.2. Country/Jurisdiction</b>	Italy
<b>1.3. Organisation</b>	Ambienthesis S.p.A., now Greenthesis S.p.A.
<b>1.4. Position</b>	CTO
<b>1.5. Duties</b>	
<b>1.6. Email address</b>	Alessandro.teani@greenthesisgroup.com
<b>1.7. Phone number</b>	+ 39 335 62 01 002

## 2. Site background

### 2.1 History of the site

The concerned area subject to the remediation is located near Milan, Italy. It's an old industrial site used before for the steel and metallurgical production activities.

The area is divided into sections and is about 1,290,000 m<sup>2</sup>, approximately.

Only the area near the railroad will be subject to the remediation activities and is about 400,000 m<sup>2</sup>, approximately.



## 2.2 Geological setting

The area of interest is flat, about 140 m above sea level. The soil is composed by gravelly-sandy and sandy alluvial deposits.

The aquifer is at a depth of 30 meters below ground surface.

The first meter of the superficial soil contains slag and other residues mixed with the soil.





## 2.3 Contaminants of concern

The major part of contaminants is composed by hydrocarbons (light and heavy) and metals (Zn, Cd, Pb, Cr).

The range of contamination is between 100 and 20,000 mg/kg for hydrocarbons and between 300 and 7000 mg/kg for metals.

During the excavations, residues of materials with asbestos were also found, as well as bombs left over from the war, and other waste that was managed separately and safely.

## 2.4 Regulatory framework

The intervention on the site is developed according to the project approved by the Italian Ministry of the Environment. The soils had to be treated with soil washing in order to allow the recovery of the fractions conforming to the future uses of the residential areas. The non-recoverable fractions that did not comply with the limits of use were sent to landfills. Some portions of land have been subjected to preliminary screening before being subjected to soil washing. Demolition residues were also subjected to volumetric reduction treatment for on-site recovery.

The remediation objectives were measured in relation to the contamination threshold concentrations allowed by Italian law for sites for future residential use, as well as in relation to the eluate for monitoring the quality of the groundwater.

# 3. Pilot-scale application in field

## 3.1 Soil washing system

There's no pilot-scale application. Only full scale application based on the lab test of the tender.

## 4. Full-scale application

### 4.1 Soil washing system

The plant is composed of few modular components, transportable and positionable on a flat waterproofed ground.

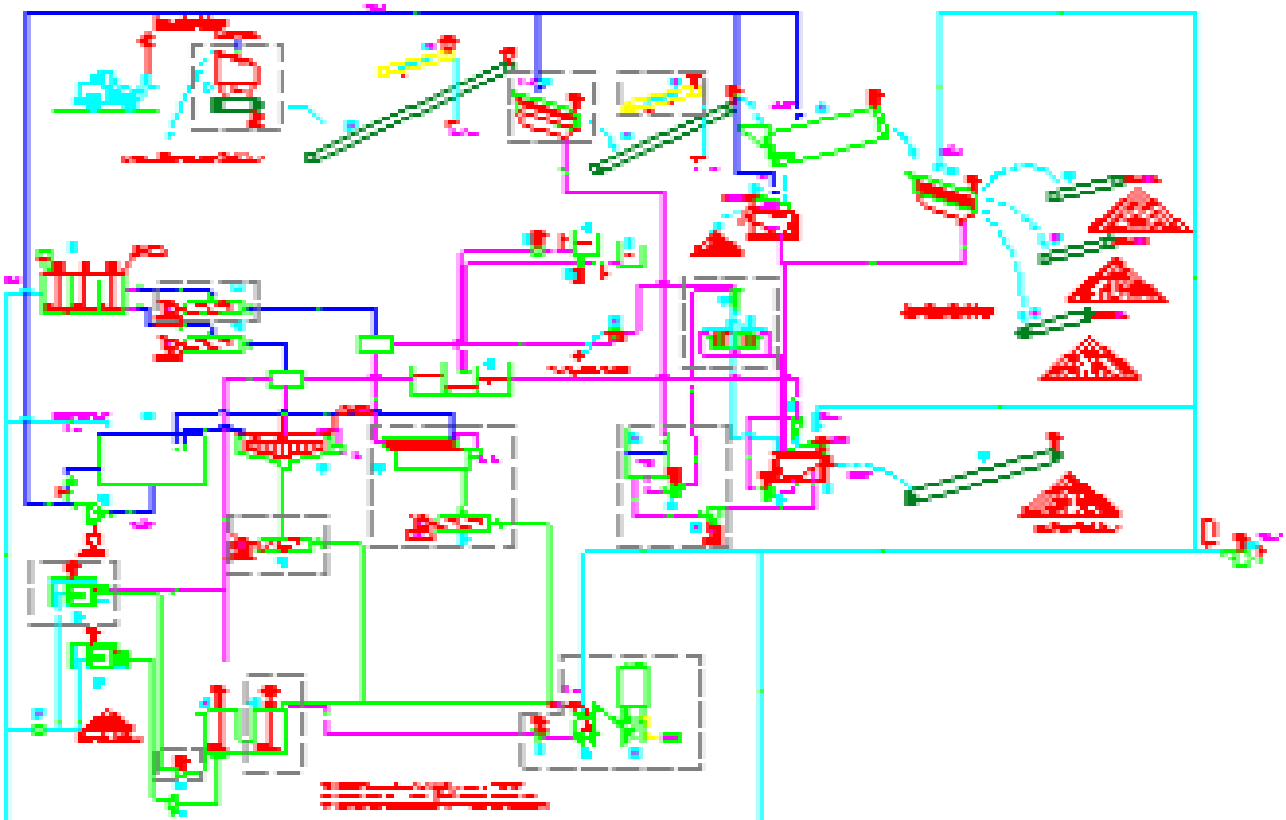

There is an overhead loading hopper, followed by a series of wet screens, capable of selecting the different cuts of sand and gravel, a drum washing, a series of hydrocyclones and the water treatment circuit with two filter presses for extraction of the sludge.

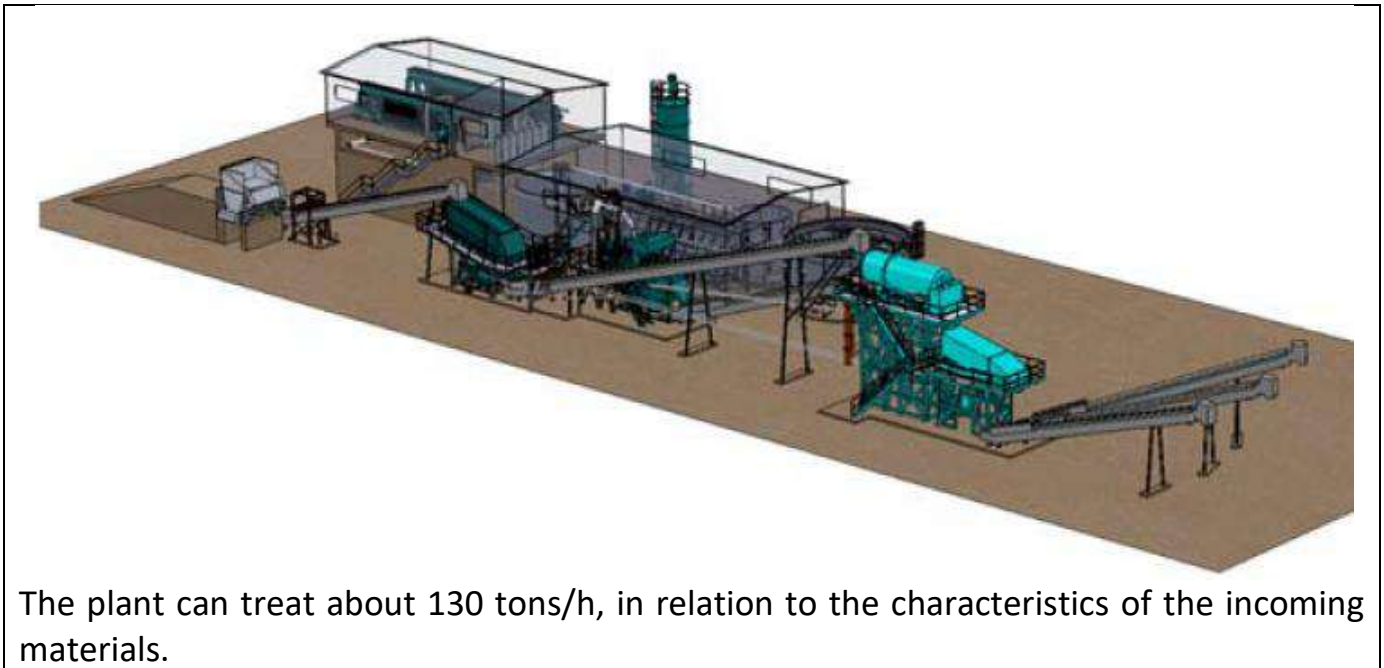

## 4.2 Feasibility study

The most present contaminants were heavy metals and TPH. The contamination level was between some ppm to 10.000 ppm.

Some hot spot were characterized by the presence of persistent contaminants (PCBs) with a concentration of 100 ppm, approximatively.

The process is performed without the use of particular additives. Only water was used, extracted from the active barrier to protect the groundwater and introduced into the washing plant.

Particular attention was paid to the granulometric aspects and to the very heterogeneous composition of the first most superficial layer which also collected residual anthropic fractions of the production process of the industrial plant.

The structure of the plant has been initially perfected and adapted to improve efficiency precisely in relation to the site-specific aspects mentioned above.



## 4.3 Water Treatment

The sludge and water are treated in the Waste Water Treatment & sludge dewatering section of the plant. The WWTP is fully automatic in operation by using Thickeners & Filter Press.

The process is composed by a closed cycle, therefore the plant was optimized through the insertion of a water purification section, sand filters and activated carbon filters.

The treatment was carried out without discharges of liquid effluents, with recharge of clean water for about 60-70 l / ton of treated soil.





## 4.4 Control parameters

The effectiveness of the treatment is related to granulometry of incoming materials, the type and quantity of contaminants.

With regard to the particle size, the treatment was applied to materials with silt and clay values <25%.

With regard to the type of contamination, the treatment was applied to organic contamination (hydrocarbons) with concentration <5000 ppm, in some cases also to hazardous waste. The treatment of metal contamination is less effective as in the anthropogenic fractions they are also found in the coarser fractions coming out of the treatment.

In any case, the material entering the plant was subjected to analytical verification (granulometric and contamination content) for batches of approximately 1000 cubic meters.

The treated materials were accumulated and also analytically verified, to check their compliance with the target limits (limits of residential sites).

In addition to the individual batches treated, the overall mass balance of the process was also checked, comparing the transfer of contamination to the individual outgoing fractions.



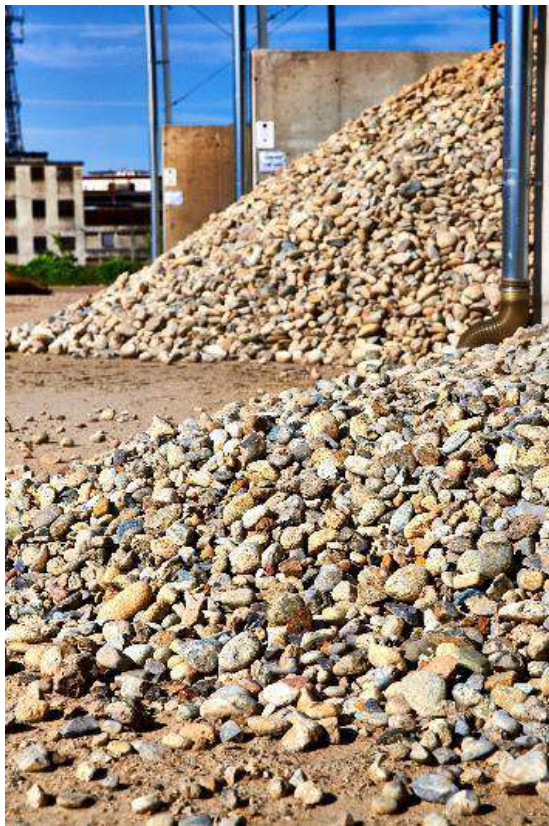



## 5. Results

### 5.1 Removal rate

Although it is possible to add chemicals to the washing solutions in order to improve the removal effectiveness, in this case the process was carried out with the use of clean water only, no additives were added.

The operation was carried out with a liquid / solid ratio of an average equal to 3.

In relation to the content of silts and clays, the hourly production remained between 30 and 70 tons / hour. However, the production is reduced with the increasing of the fine fractions.

75.000 tons of contaminated soil were treated per year, recovering about 75% of the output materials produced.

The contamination abatement efficiency has proved to be excellent in the case of organic contaminants (> 90%), lower in the case of inorganic contaminants.

In this case the inorganics contaminants will be found in the final treated soil.

## 6. Post treatment and/or Long Term Monitoring

### 6.1 Post treatment and/or Long Term Monitoring

The procedures envisaged by the approved project do not contemplate long-term checks on the processed material. Instead, checks were carried out on elution, in order to safeguard the groundwater where the material was relocated.

All the recovered materials met the conditions envisaged for the protection of the groundwater, guaranteeing levels of contamination in the eluates compatible with the contamination limits envisaged for the groundwater.



## 7. Additional information

### 7.1 Lesson learnt

The intervention carried out allowed to highlight the following success and limits of the process:

- particle size distribution of the matrix being treated (more clay and silts means less efficiency and sustainability of process).
- the anthropogenic fractions.

We can say that:

- organic contamination can be treated with good results
- the process can work without water discharges
- In absence of particular contaminants, the process proves effectiveness even without the application of additives
- Prior to application on an industrial scale, it is convenient to acquire information on contamination, particle sizes, availability and cost of the landfill where the unrecovered fractions are to be delivered.

If adequate space and time are available in the reclamation sites, the application of soil washing can undoubtedly allow the saving of considerable economic resources and the recovery of land otherwise destined for disposal.

### 7.2 Additional information

The installation of a plant with capacity of treatment equal 50 tons / hour requires an average surface area of 1 hectare, to have the spaces for maneuvering and accumulating materials. It is possible to conduct the treatment H24, operating on average with 4 operators and two work vehicles. An average of 1 day of ordinary maintenance every week is to be foreseen.

Treatment costs are between € 20 and € 50/ton, approximately, excluding the disposal of waste in landfills. To consider separately the costs of procurement and installation of the plant.



### **7.3 Training need**

Running a soil washing plant requires experience in the geological, chemical and mechanical fields. The management of the process is completely automatic and can be carried out, even remotely, by a process engineer. A supervisor must be present on site, able to coordinate 1 maintenance technician and 2-3 operators.

It is important to have a collaboration with chemists able to evaluate the quality of incoming and processed materials, to allow free space in the storage areas and operational continuity.

### **7.4 Additional remarks**

Applying soil washing treatments to reclamation sites is very different from applying the same technology to fixed plants. In remediation sites, the quality of the materials to be treated is usually not programmable and / or selectable. It must be managed and processed in real time. Often the technical characteristics of the plant are also defined specifically for the site, therefore it is essential to have qualified personnel who know how to better manage the situation, as well as to have characterization data as reliable as possible.

It is important to ensure an organization and documentary availability such as to allow the best traceability of flows, from the origin of the excavation to the recovery location.



## 1. Your contact details - CASE STUDY: SW n.2

<b>1.1. Name and Surname*</b>	Dr. Benjamin Faigle
<b>1.2. Country/Jurisdiction</b>	Germany
<b>1.3. Organisation</b>	Züblin Umwelttechnik GmbH
<b>1.4. Position</b>	Deputy Manager R&D
<b>1.5. Duties</b>	In-situ methods, PFAS remediation
<b>1.6. Email address</b>	benjamin.faigle@zueblin.de
<b>1.7. Phone number</b>	Tel. +49 (0)7145 9324-249



## 2. Site background

### 2.1 History of the site

The German city of Ingolstadt is conveniently located between the Bavarian cities of Nuremberg, Regensburg, Munich and Augsburg, and was thus selected as the place to erect five oil refineries in 1960. After construction began in 1962, the oil refinery ERIAG (“Erdölraffinerie Ingolstadt AG”) began its operation on this specific site in 1964, and commenced in operation until 2008, when decommissioning of the operational site began.



Figure 1: Areal view of the site of the former oil refinery. Copyright: AUDI AG

The main tank fields and processing plants and chimneys were dismantled from 2010-2013, and 75ha out of a total of 105ha of land was acquired by IN-Campus GmbH, a Joint venture of AUDI AG and the City of Ingolstadt.

Thorough investigations into contamination at the site were conducted beginning in 2007. These primarily involved exploratory investigations and detailed investigations in multiple stages with downstream remediation investigations. After the site was acquired by IN-Campus GmbH, investigations were stepped up and an analysis carried out focusing



on its later use as a research and technology campus.

A total of over 1,200 exploratory drilling operations and digs were carried out and tests conducted at over 250 groundwater control points over the years. Three groups of contaminants have been identified: Petroleum-derived hydrocarbons (C10 - C40) can be found from groundwater level down to depths of up to 8 m below the groundwater level. Volatile aliphatic (C5 – C9) and aromatic hydrocarbons (BTEX) are present in the groundwater as well as in the unsaturated zone. And Polyfluoroalkyl substances (PFAS) are observed in the upper layer of the soil and in the groundwater.

In 2016, a remediation contract got approval, and remediation efforts began.

In 2017, a consortium of companies ZÜBLIN Umwelttechnik GmbH, Geiger Umweltsanierung GmbH, Wilhelm Geiger GmbH & Co. KG und Strabag Umwelttechnik GmbH was attributed with the remediation of the main area of 50 hectares.

## 2.2 Geological setting

The site is located next to the river Danube and abandoned meanders. Therefore, the soil consists of former fluvial deposits, which means it is largely sandy gravel with small content of fine material, so the soil is appropriate for the treatment method of soil washing.

The groundwater table lies around 1-3m below Surface level, and is mainly governed by the level of the river Danube, which is controlled by dams. Due to the soil's high permeability, the natural flow velocity of the groundwater is very high and lies between 2 and 6 meters per day. Approximately 6-8m below groundwater level, a dense layer is addressed as the base of the first aquifer.

## 2.3 Contaminants of concern

The input material featured the following range of contaminants:

- TPH (BDL – 10,000 mg/kg)
- C5-C9 (BDL – 1,000 mg/kg)
- BTEX (BDL – 500 mg/kg)
- PFAS (BDL – 20 µg/l) with main compound PFOS



## 2.4 Regulatory framework

- A general remediation strategy was developed that acknowledges the sites future usage as an industrial site. An integral part of this strategy was the method of soil washing, with the potential to reuse the clean output fractions on site.
- The soil treatment plant was designed and permitted exclusively for on-site treatment of contaminated soil originating from the former refinery site in Ingolstadt.
- Treatment targets for the washing process and the output fraction is defined by the remediation plan for the former refinery site as criteria for backfill soil
- The soil washing plant plant is permitted acc. to German Legislation BImSchG “Bundes-Immissionschutzgesetz”. The permit includes all attendant facilities such as the treatment facilities for the washing fluid, the legal framework for material flow (clearance of material before and after soil washing) as well as safety precautions for the workforce on the site.

## 3. Pilot-scale application in field

### 3.1 Soil washing system

- Pilot tests were carried out in a company-owned soil washing plant in Germany, involving 100 t of contaminated soil.
- As the pilot system was able to produce soil without relevant PFAS contamination, the pilot test showed that the contaminated material is washable on a scale larger than typical laboratory tests. The main contaminant sink was the washing water; hence an elaborate treatment procedure for the washing fluid is essential.



## 3.2 Feasibility study

### General Parameters

- Integrated remediation concept setting feasible conditions for the treated soil to be reused as backfill soil on the site
- Suitable contaminant inventory
- Average grain size distribution curve suitable for washing process
- Coarse soil characteristics simplifies the technical treatment steps for soil washing
- As the filter cake needs to be disposed of, a low clay content of the soil is economically beneficial.
- Large soil quantities requiring treatment to allow the installation of an on-site treatment facility
- Space requirements for on-site treatment fulfilled

### Minimum requirements in regards of soil quality:

- Detailed preliminary investigation in regards of contaminant inventory and soil quantities
- Representative grain size distribution curves from relevant contaminated soil zones (e.g. at different depth intervals)
- Detailed description of the soil incl. e.g. content of organics, non soil fraction like debris and other waste, existence of agglomerations etc.

## 3.3 Water Treatment

- Granulated activated carbon
- Reactivation of used activated carbon off-site



### 3.4 Control parameters

**The following prerequisites are essential for the pilot test:**

- Representative selection of soil for the pilot test
- Setup and execution of a detailed monitoring programme

**During the pilot test, the following degrees of freedom should be investigated:**

- Test run at different performance levels
- Test run involving different potential treatment steps

**The feasibility full scale can then be determined by means of:**

- Evaluation of the treatment efficiency for an outlook on the overall project
- Design of a mass balance and mass flow, depending on necessary projected treatment steps
- Definition of feasible disposal procedures and reuse strategy for the resulting output depending on the expected material quality per output stream. Here, the expected output mass balance comes into play.

## 4. Full-scale application

### 4.1 Soil washing system

#### Overview

- In the period from 2018-2021, a total of 150,000t of soil mainly contaminated with PFAS and an additional of 280,000t of material with hydrocarbons have been successfully washed and reused on the site. Overall, a total of 430,000 t of contaminated material has been washed in this project.
- From the remediation areas, the excavated material is transported onto a sealed area comprising over 25,000m<sup>2</sup>, and therein into an enclosed unloading area equipped with off-gas treatment. An encased conveyor belt feeds the contaminated material into the soil washing plant (Figure 2).



Figure 2: Areal view of the soil washing plant (front), sludge treatment facility (left hand side) and the reception hall (in the back).  
Copyright: ARGE AUDI IN-Campus GbR.

#### The core-unit for soil washing

- The feeding station is located in the receiving hall to prevent emissions of dust and volatile substances. An encased conveyor belt transports the contaminated material upwards to the uppermost point of the washing tower.
- The rather coarse fraction from the first classifying screen enters a powerscrub logwasher to break up loamy bulbs.

- The material then passes several vibrating screens of different sizes, where the material is washed with the washing fluid applied with various spray bars
- The fine sands are washed and separated from the process water in the hydrocyclone.
- Washing fluid is recirculated in a closed cycle, which is both environmentally friendly and cost-saving
- Only pure water but no additives like tensides and the like are used

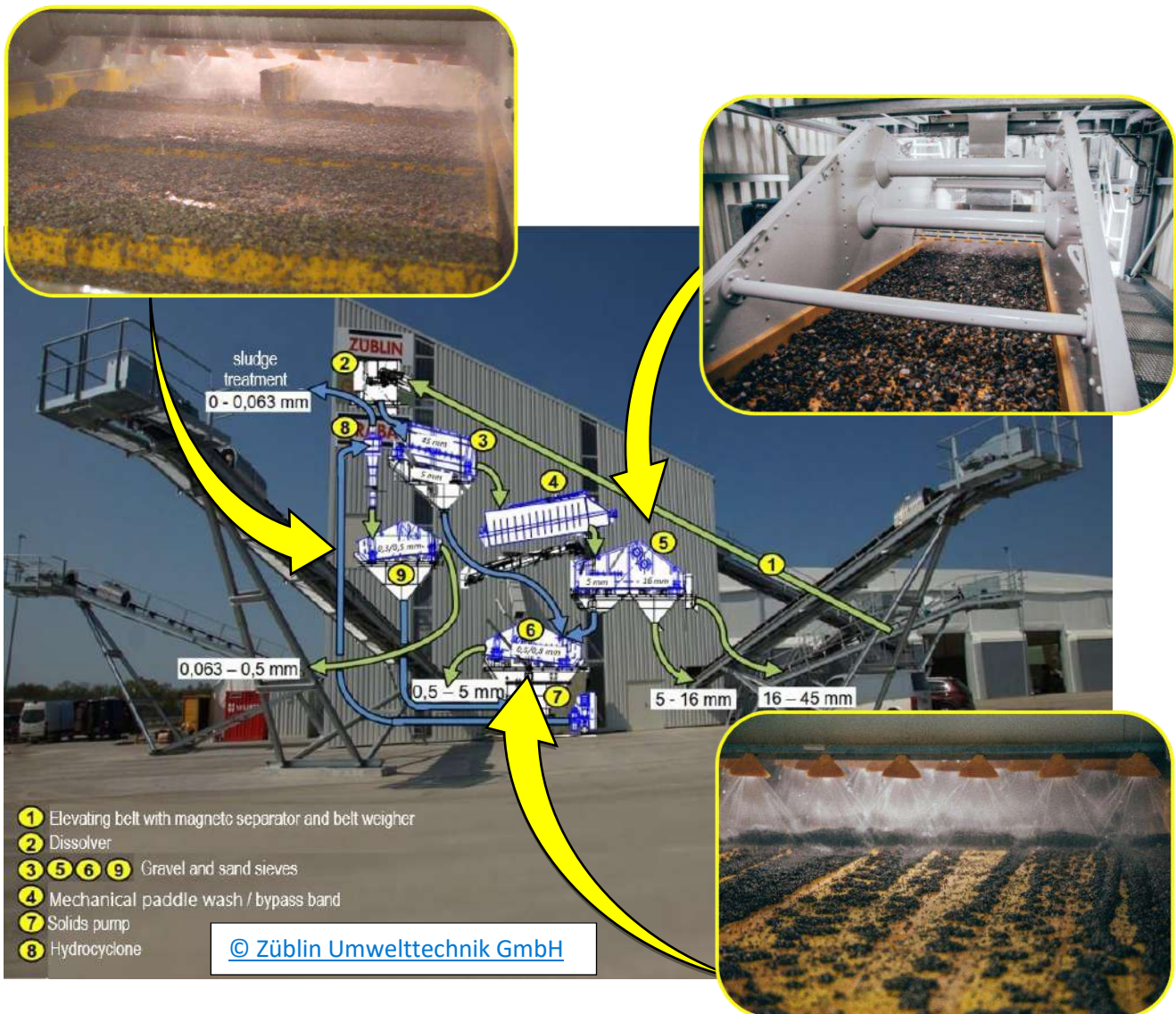

Figure 3: Treatment steps of the soil washing plant.

## 4.2 Feasibility study

- The plant was designed and customized for the project. As such, treatment targets were reached after the first treatment cycle.
- The single treatment steps are described in Chapter 0.1 (solid matter) and 0.3 (sludge and water).

## 4.3 Water Treatment



Figure 4: Areal view of the sludge treatment plant, Copyright: ARGE AUDI IN-Campus GbR.



Washing fluid is recirculated in a closed cycle

- The process water is rich with sediments and is processed in a sludge treatment plant with a capacity of 400 m<sup>3</sup>/h (Error! Reference source not found.). The slurry water originating from the hydrocyclone is homogenised and pumped to the flocculation step, after which separation is achieved by baffle plate thickeners. The separated clear water is still loaded with contaminants, so the water is transferred to large buffer basins for further treatment.
- After separation, the sludge is dewatered by a fully automated filter press (Error! Reference source not found.). The filter cake constitutes the sink for the contaminants. As the filter cake gets disposed on landfills at high costs, especially if PFAS are involved, it is economically reasonable to reduce the water content as low as possible to values below 30 %.



Figure 5: Chamber press, the small picture shows the filter cake, Copyright: ARGE AUDI IN-Campus GbR.

- After the sludge treatment, the clear water is transferred to its final treatment step, the water treatment plant (Error! Reference source not found.).



Figure 6: Water management using large basins to reduce the capacity of the water treatment plan, Copyright: ARGE AUDI IN-Campus GbR. The water treatment units purifies approximately 140 m<sup>3</sup>/h of clear water, removing the dissolved contaminants with sand filters and activated carbon. Depending on the contaminations at hand, different types of activated carbon are employed to optimize the adsorption capacity. A share of the washing fluid is lost by adhesion to the output soil, and needs to be replenished with fresh water (external supply).



## 4.4 Control parameters

A thorough monitoring program for the output material is essential to establish the reliability in the washing process. The monitoring has to be performed by an independent external expert, who is then responsible for correctly and regularly sampling, analytics and clearance of each output batch, see Chapter 0.

The target values depend on local regulatory requirements and the project-specific range of contaminants involved.

An additional analytical monitoring program by the operator of the soil washing facility is only recommended, for the supervision and establishment of the operation parameters.

For the sludge and water treatment, the typical control parameters such as samples for settling time for the quantification of the flocculation agents, fluid levels in buffer tanks or pressure drops in filter are relevant for a safe and uninterrupted operation of the treatment facilities. As these are not special to the process of soil washing, their detailed description is omitted in the report.

In this project, only purified groundwater but no washing supplements have been employed.

## 5. Results

### 5.1 Removal rate

The output soil quality after treatment was as follows:

- TPH (BDL - <100 mg/kg)
- C5-C9 (BDL – 1 mg/kg)
- BTEX (BDL – 1 mg/kg)
- PFAS (BDL – 0.1 µg/l) with main compound PFOS

In this project, no washing supplements have been employed, the target values could be achieved with proper operation conditions (high volume of washing water, appropriate flow input material).



## 6. Post treatment and/or Long Term Monitoring

### 6.1 Post treatment and/or Long Term Monitoring

- The Output of the soil washing plant was stockpiled by means of a frontloader.
- Output fractions “sand” and “gravel” were stockpiled separately
- After target pile size of 500 m<sup>3</sup> was reached , sampling acc. to relevant regulation was performed by an independent external consultant
- Long term monitoring is not required

## 7. Additional information

### 7.1 Lesson learnt

The project was successfully completed in 2021, one finds that:

- Soil washing turned out to be a very effective technology for the given contaminant inventory
- Over the duration of several years, the treatment procedure was stable and reliable
- Low energy consumption and CO<sub>2</sub>-footprint compared to alternative solutions (e.g. thermal desorption or off-site disposal on landfills)
- Competitive price under the given site conditions

Over the duration of plant operation, the relevant mass fluxes were monitored to prepare a contaminant mass balance, see the following figures. As the concentrations measured are not totally precise, the depicted values are not corrected in order to gain round sums, but are kept as they were as an indicator of the accurateness of the flow chart.

Owing to their physical properties, PFAS tend to the water phase and do not adhere to the solid fraction. Therefore, the main sink for PFAS-removal is the activated carbon at the end of the water treatment, see **Error! Reference source not found..**

Hydrocarbons in contrast remain attached to solid particles and are concentrated in the filter cake, see **Error! Reference source not found..**

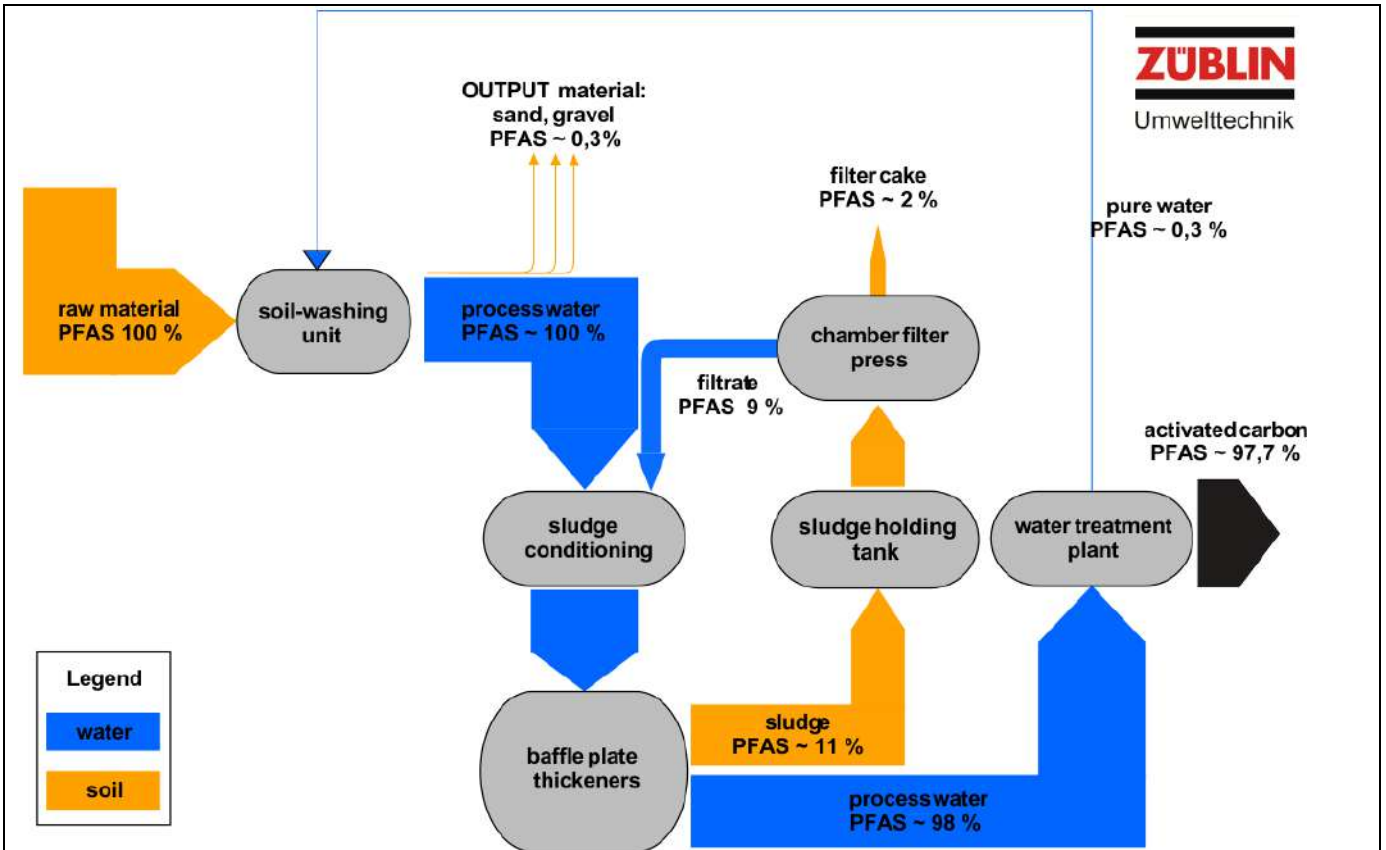

Figure 7: Contaminant sink for the removal of PFAS: water path and activated carbon.

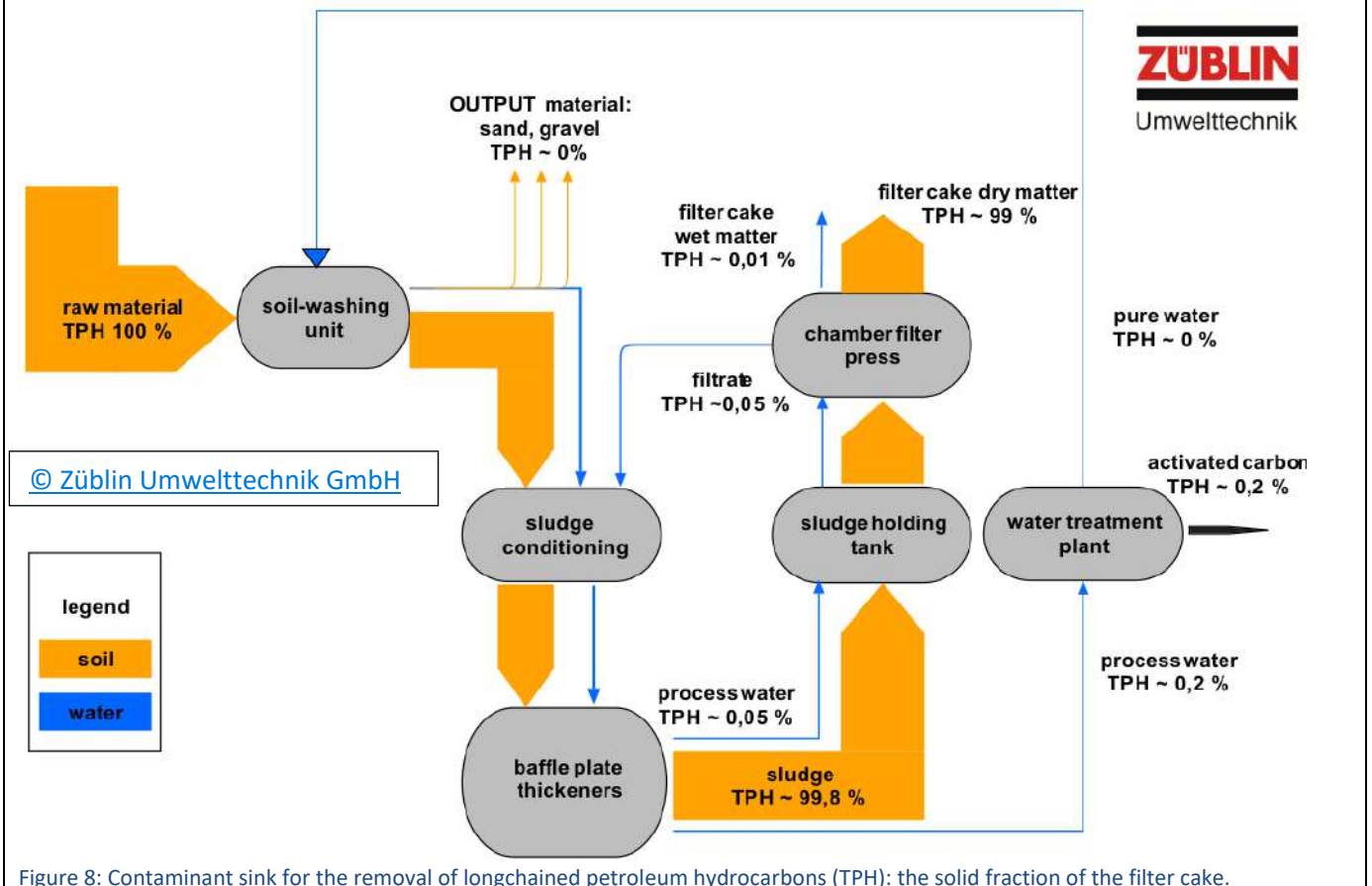

Figure 8: Contaminant sink for the removal of longchained petroleum hydrocarbons (TPH): the solid fraction of the filter cake.



## 7.2 Additional information

During the operation of the soil washing plant, it was used as a testing facility for many other remediation sites for washing tests under field-scale conditions. Typically, between 200-500 t of contaminated material was investigated. In all cases, even material deemed hardly washable because of certain criteria (too high content of recycling material; low percentage of coarse gravel; relatively large fine fraction; etc.) have been successfully washed. Therefore, one should refrain from defining hard criteria allotted with the soil structure for declaring a material to be washable or not. Whether soil washing is an economically feasible method may be a tough decision, which can be answered if a pilot test investigates the limits and potential of the washing procedure, see chapter 0.4. In many cases, however, a soil-washing strategy can be developed without a pilot test.

## 7.3 Training need

Especially with recent contaminants without long-lasting remediation experience such as PFAS, there is a tendency to doubt that soil-washing of large quantities of contaminated material can be reliably successful and economically attractive. To overcome these doubts, site visits to existing project might be a useful instrument to acknowledge that there is a technical solution apart from disposal in landfills.

Basic requirements and site conditions of the soil washing technology is described in this report. As the success of the washing procedure depends on a variety of operation parameters, specialists should be consulted. For pilot tests or a feasibility study for a specific project, competent companies with a wide range of longterm experience should be involved in the decisionmaking. As every project provides its own unique challenges, one should be critical from generalising statements such as “soil-washing is not possible for the given material”.



## Glossary of Terms

<b>Term (alphabetical order)</b>	<b>Definition</b>
BDL	Concentration which is below the detection limit.
BTEX	Benzene, toluene, ethylbenzene and xylenes
C5-C9	Volatile hydrocarbons with a chainlength of five to nine.
CHC	Chlorinated aliphatic hydrocarbons
PAH	Polycyclic aromatic hydrocarbons
PFAS	Per- and polyfluoroalkyl substances (PFASs) are synthetic organofluorine chemical compounds that have multiple fluorine atoms attached to an alkyl chain.
TPH	Total petroleum hydrocarbons
VOC	Volatile organic compounds (VOCs) are organic chemicals that have a high vapor pressure at ordinary room temperature



## 1. Your contact details - CASE STUDY: SW n.3

<b>1.1. Name and Surname*</b>	Massimiliano Confalonieri Beatrice Melillo Paola Canepa
<b>1.2. Country/Jurisdiction</b>	Lombardy Region (Italy)
<b>1.3. Organisation</b>	Environmental Protection Agency
<b>1.4. Position</b>	
<b>1.5. Duties</b>	
<b>1.6. Email address</b>	<a href="mailto:m.confalonieri@arpalombardia.it">m.confalonieri@arpalombardia.it</a> <a href="mailto:b.melillo@arpalombardia.it">b.melillo@arpalombardia.it</a> <a href="mailto:p.canepa@arpalombardia.it">p.canepa@arpalombardia.it</a>
<b>1.7. Phone number</b>	



## 2. Site background

### 2.1 History of the site

The contaminated site is located in the south east of Milan (about 5.5 km from the center of the city) and it covers 641.000 m<sup>2</sup>. Since 1910, in these area, there was a chemical industry (Montedison Spa) that produced fertilizers (e.g. Rogor); the industrial plant operated until the 1970s.

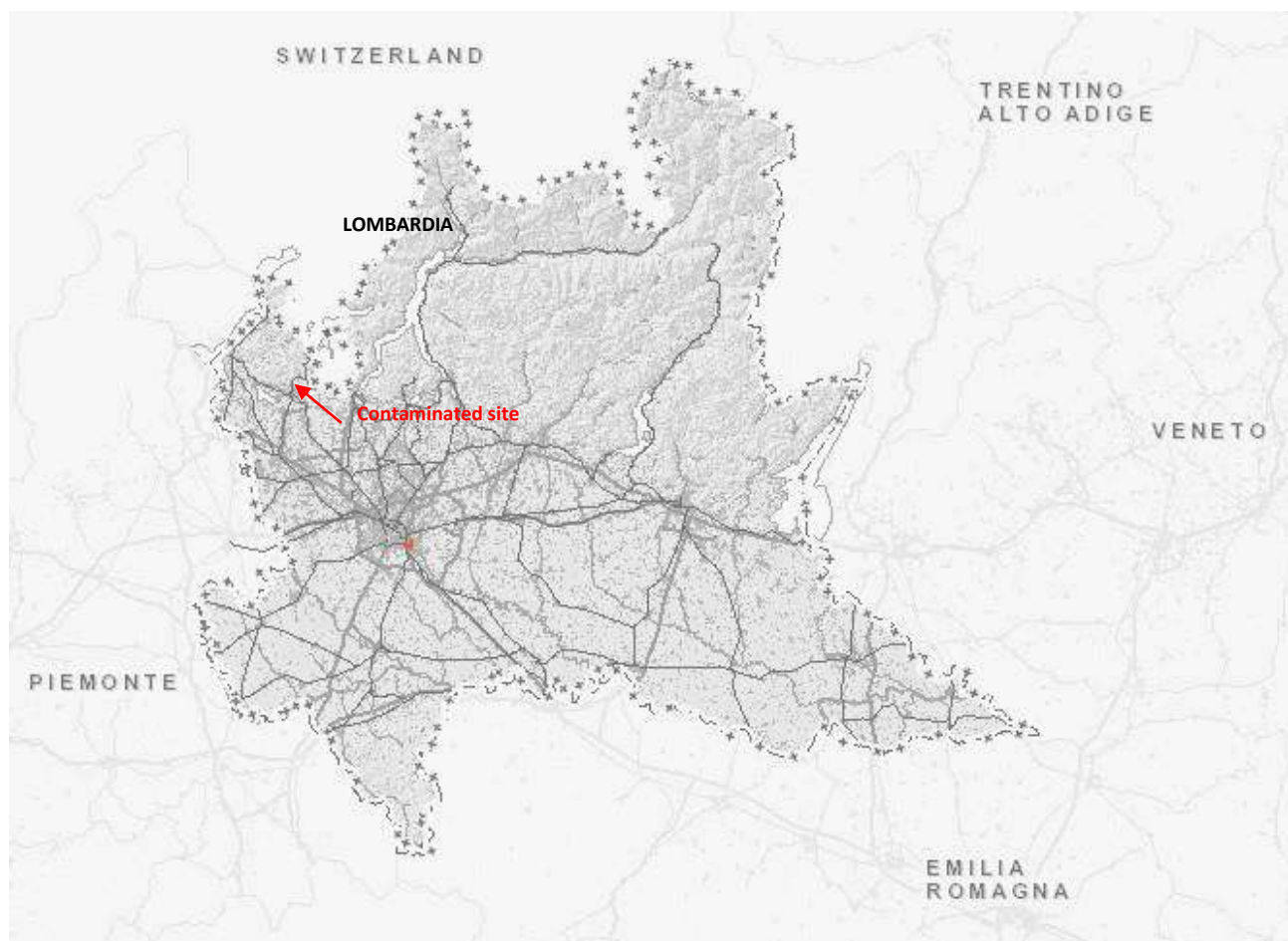

Figure 9 - Location of the contaminated site within the Lombardy region

This area (the so-called "North Area") corresponds to a part of a large urban redevelopment project ("Montecity-Rogoredo" Integrated Intervention Program), started in 2005. The project covers an area of about 1.100.000 m<sup>2</sup>; it is aimed at re-qualifying a large abandoned industrial area previously occupied by the Montedison plants to the north and the Redaelli steel mills to the south. The area is located in a strategic point of the city as it is between the Milano - Rogoredo station (the station through which the high-speed railway line passes), the eastern Milan ring road and the Linate airport.

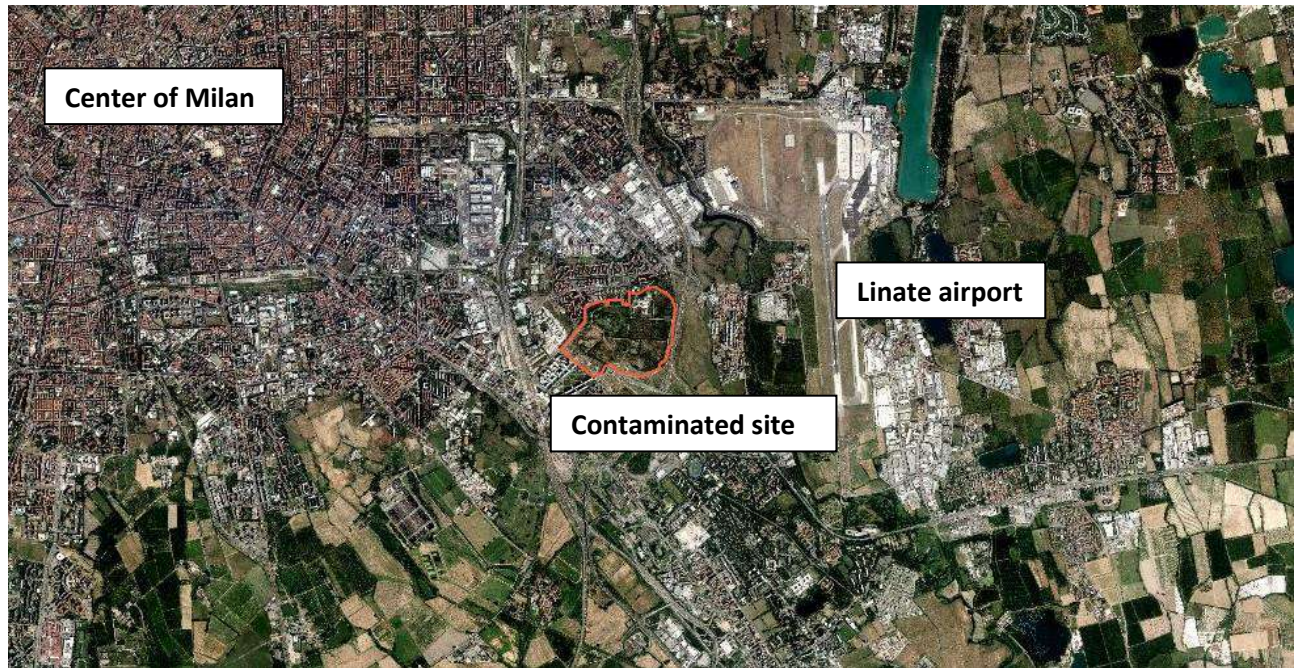

Figure 10 - Location of the contaminated site (in red) with respect to the city center and Milan Linate airport



Figure 11 - Location of the contaminated site (in red), with respect to the railway station and the eastern ring road of Milan

## 2.2 Geological setting

The area is characterized by a “backfill” layer (a mixed layer of variable grain size soil and anthropic materials, e.g. fragments of brick and firebrick, concrete, fewer slag) located above natural terrain consisting of gravels and sands. The thickness of the “backfill” layer varies from some tens of centimeters to a few meters.

The depth to ground water is between 4,5 e 8,5 meters below ground surface.

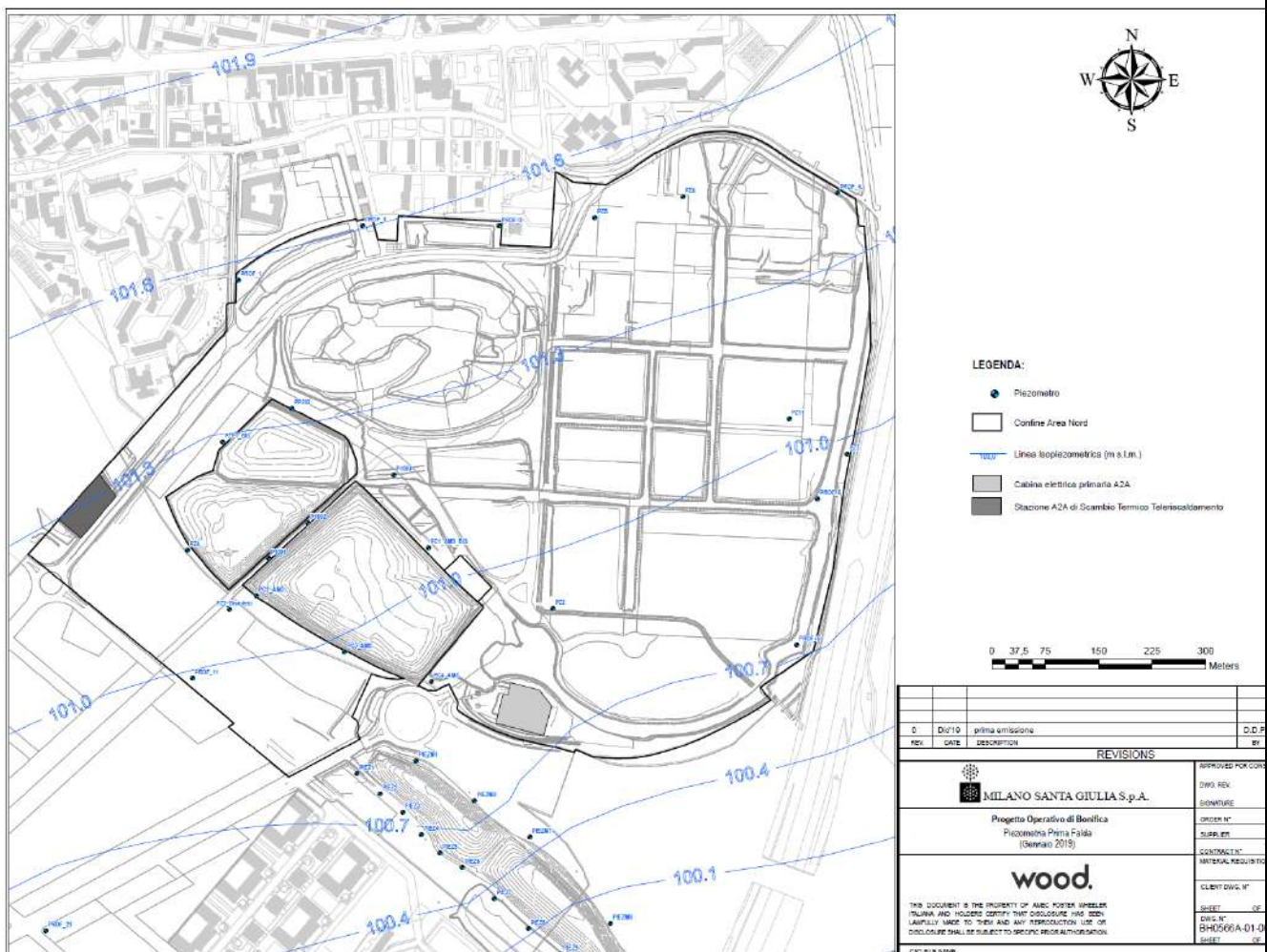

Figure 12 – Water table (January 2019)

Locally, at an average depth of 6 m from the ground level, there is a layer of sandy-clayey silt; the maximum observed thickness of the clay lens is 2,6 meters. A perched water table is located above this clay lens.

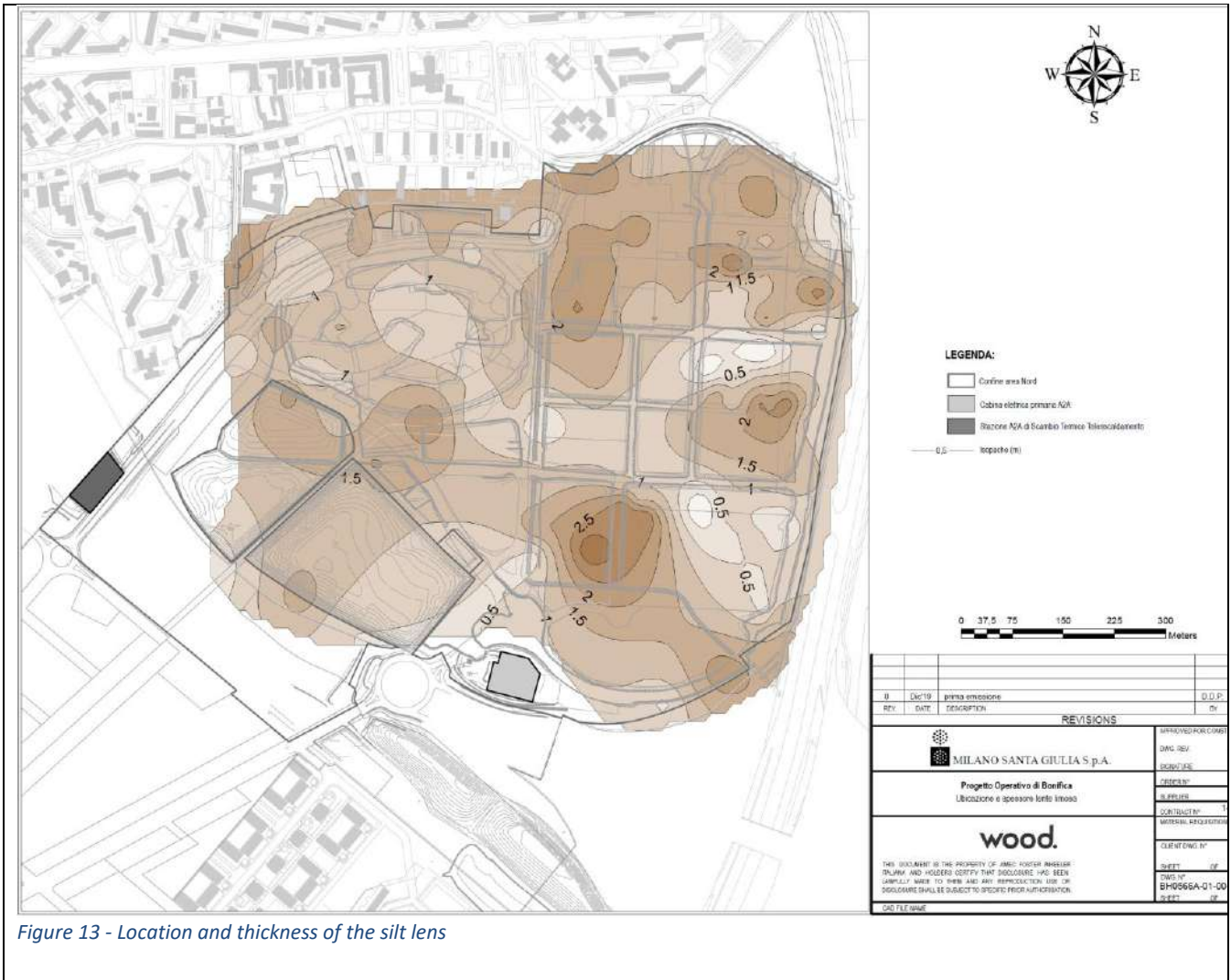

Figure 13 - Location and thickness of the silt lens

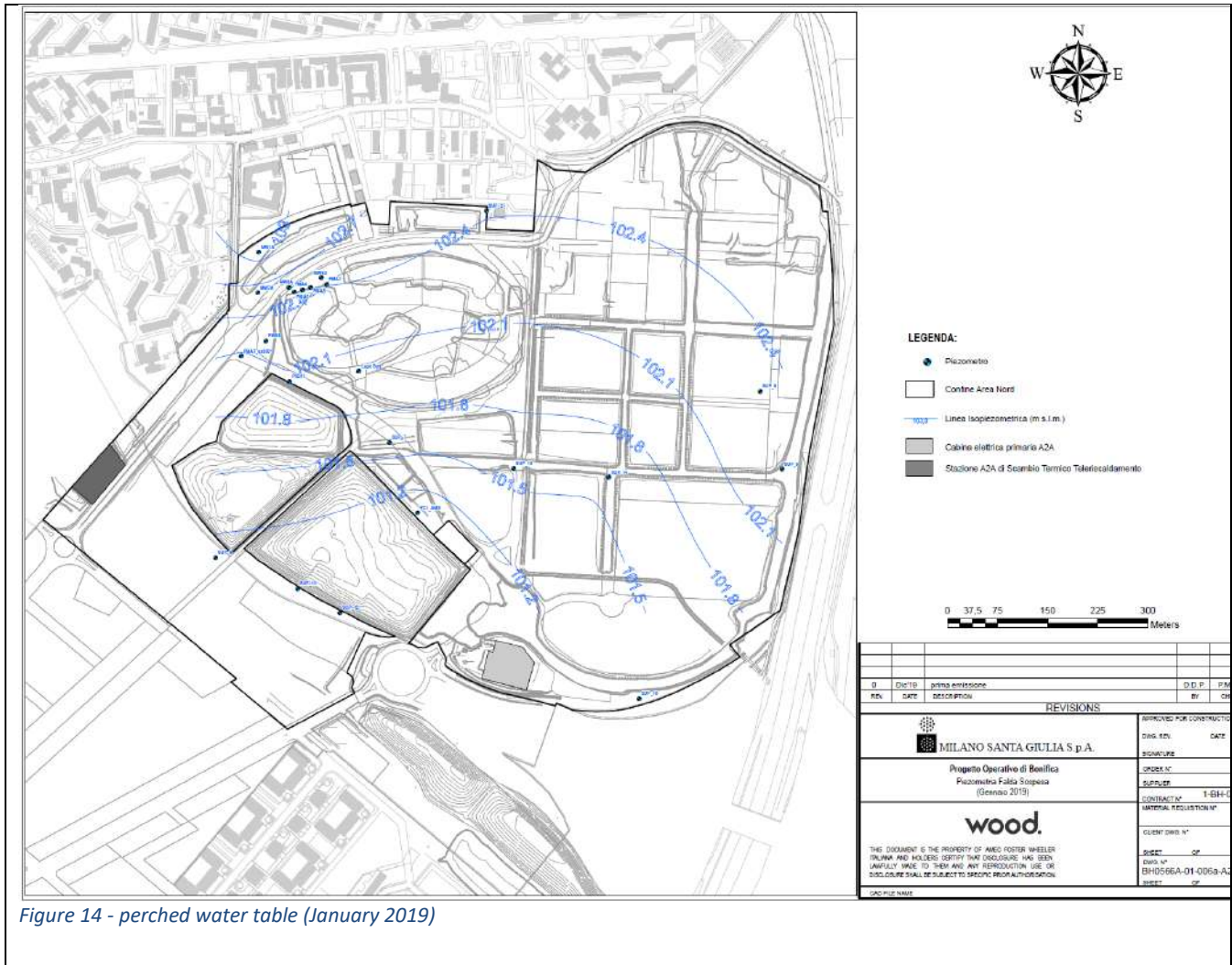

Figure 14 - perched water table (January 2019)

## 2.3 Contaminants of concern

### Backfill material and soil:

- Metals (mainly Zinc, spread throughout the area, and secondly As, Cd, Cr tot, Pb, Cu e Hg)
- BTEX
- PAH (Polycyclic Aromatic Hydrocarbons), PCBs.
- Chlorinated Solvents and Chlorobenzenes (mainly Hexachlorobenzene)
- Pesticides (mainly DDT, DDD and DDE)
- Light Hydrocarbons (C< 12) and Heavy Hydrocarbons (C>12)

Most of the samples that exceed the legal limit concentration, for one or more parameters, are backfill material samples.

**Groundwater:** Organic halogen compounds, Metals and Pesticides.

## 2.4 Regulatory framework

The contaminated site covers 641.000 m<sup>2</sup>; about 65% of this area (about 408.000 m<sup>2</sup>) is intended for residential use and about 35% (about 233.000 m<sup>2</sup>) is intended for commercial use. According to the intended use of the area, the concentration of contaminants was compared with the legal limits referred to in Legislative Decree 152/06 and subsequent amendments, part IV, title V, annex 5, table 1 - Column A or B; the comparison shows that most of the samples that exceed the legal limit concentration, for one or more parameters, are backfill material samples.

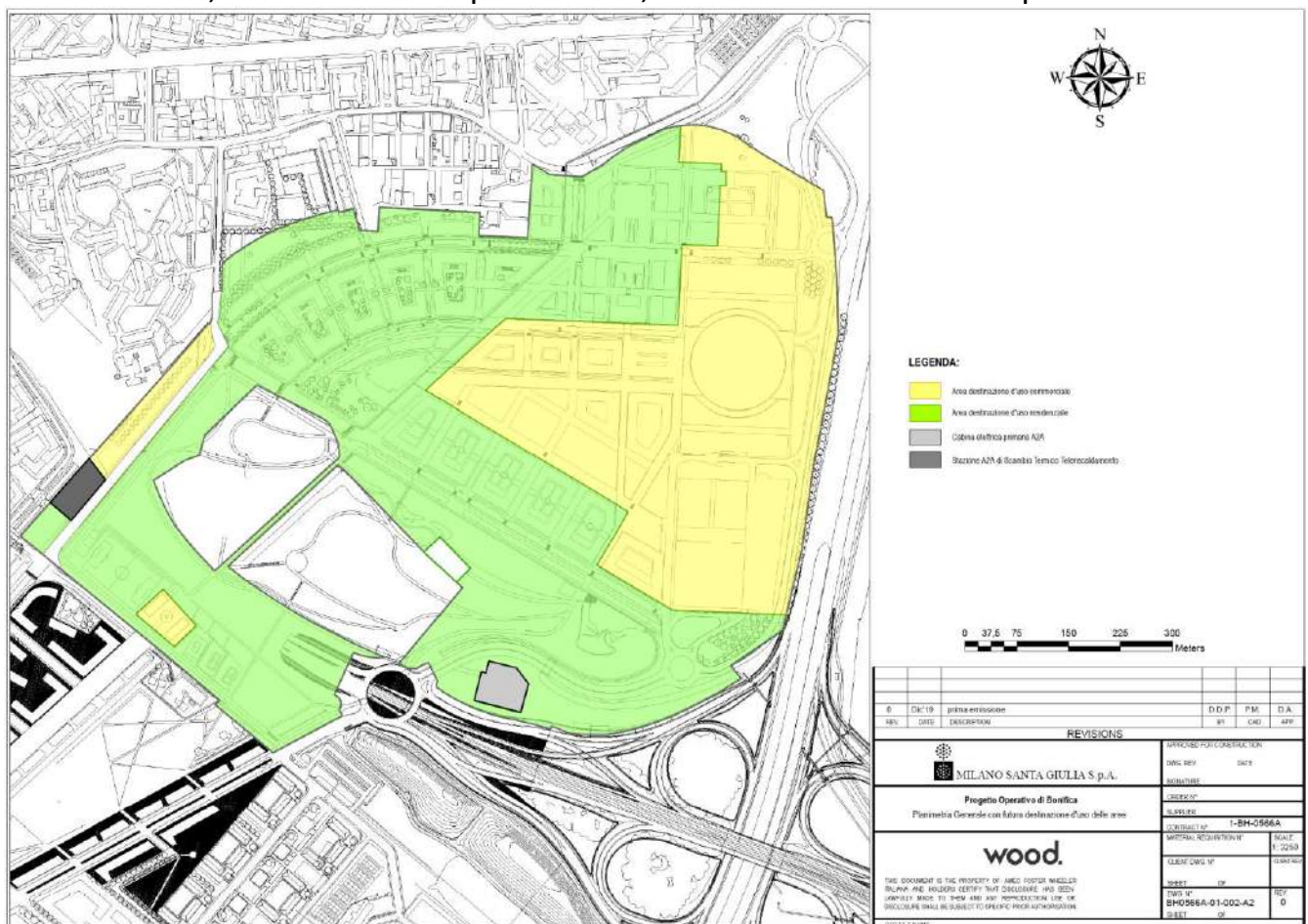

Figure 15 – Intended use of the site: residential (in green) or commercial use (in yellow)

The remediation objectives for the this site were calculated with the Risk Analysis; for some Metals (Cd, Pb, Cu and Zn) the maximum concentration detected on site (C<sub>max</sub>) was taken as the remediation objective. The remediation target for the excavated material (soil and fill materials) that will be reused on site is the legal limits referred to in Legislative Decree 152/06 and subsequent amendments, part IV, title V, annex 5, table 1 - Column A or B, according to the intended use.

### 3. Pilot-scale application in field

#### 3.1 Soil washing system

The pilot test was conducted on about 310 m<sup>3</sup> of material and involved two phases:

1. Soil screening (on-site) with a mobile soil screener: the soil was separated in pebbles ( $\varnothing > 50$  mm), coarse and medium gravel ( $8 \text{ mm} < \varnothing < 50$  mm) and finer fractions of soil ( $\varnothing < 8$  mm, that is fine gravel, sand, silt and clay). Each particle size fraction was weighed to define the particle size distribution. An average sample of each particle size fraction was subjected to chemical analysis to evaluate its qualitative status. The fine materials ( $\varnothing < 8$  mm, about 53% of the excavated material) have been sent to a suitable authorized disposal or recovery plant.

	IN		OUT					
	Ingresso (% dello scavato)	% in peso	N° campioni	% Eluato conforme (Tab. 2 D.Lgs. 152/06 Acque)	% Tal quale conforme (d.u. Commerciale)	Destino	% Riutilizzo del Terreno Scavato	
							Residenziale	Commerciale
<8mm	100%	53%	9	0%	11%	Smaltimento/ Recupero Offsite	0%	0%
8-50mm		40%	9	0%	N.A.	Smaltimento/ Recupero Offsite	0%	0%
>50mm		7%	9	78%	N.A.	Riutilizzo Onsite	5%	5%

Figure 16 - Quality of the excavated material after on site screening

2. Crushing and washing (off site) at an authorized Soil Washing plant: only the coarser fractions of soil ( $\varnothing > 8$  mm, 47% of the excavated material ~ 210.320 tons) were washed (material treatment flow: about 20 t/h). Only water was used for washing.

The plant that was used for the pilot test consists of a jaw crusher, a star screener equipped with an iron remover, an aggregate scrubber, a horizontal wet vibrating screener, n. 2 hydrocyclones, a vibrating dryer and a water treatment system.

In the following table, particle size distribution of the washed material (210.320 tons of material) is indicated:

FRAZIONE OUT SW	Peso materiale lavato (tonn)	Ripartizione % materiale sul totale entrante
> 2/3mm	145.340	69,10%
0,06-2/3 mm	41.340	19,66%
Fango (<0,06 mm)	23.640 (*)	11,24%



The fine material (0,06 -2/3 mm) resulting from the washing treatment derives from the primary crushing and removal of the particulate adhering to the coarse material.

IN		OUT						
Ingresso (% dello scavato)	% in peso	N° campioni	% Eluato conforme (Tab. 2 D.Lgs. 152/06 Acque )	% Tal quale conforme (d.u. Commerciale)	Destino	% Riutilizzo del Terreno Scavato		
						Residenziale	Commerciale	
fango		11%	3	0%	N.A.	Smaltimento/ Recupero Off/site	0%	0%
0.063-3mm	47%	20%	5	80%	100%	Riutilizzo Onsite	0%	8%
3-50mm		69%	6	100%	N.A.	Riutilizzo Onsite	30%	30%

Crushing and washing of the coarser ( $\varnothing > 8$  mm) fractions of soil (about 47% of the total excavated material) produced little sludge to dispose of (about 11%) and washed materials (about 89%); 20% of these materials are made up of sand and 69% of gravel. The washed material was subjected to chemical analyses to assess its compliance with legal limits: 38% of the excavated material is suitable for reuse in commercial areas and 30% in residential area.

### 3.2 Feasibility study

Based on the experience of Amec Foster Wheeler Italiana srl, Soil Washing does not give satisfactory results if it is applied to soils with a percentage of fine materials ( $\varnothing < 0,06$  mm) greater than 20%. Generally speaking, the higher the percentage of sand and coarse material, the more effective the washing process will be.

### 3.3 Water Treatment

The soil washing tests were performed in an authorized plant outside the contaminated site, therefore the wastewater treatment plant is not described in the remediation plan.

### 3.4 Control parameters

To assess the removal efficiency, the contaminants of concern are measured at the output of any washing cycle.





## 4. Full-scale application

### 4.1 Soil washing system

The soil washing facility was started up in early March 2022; the information below comes from the remediation project of the area and describes the plant as planned and not after its construction.

The soil washing facility includes:

- **Pre – Screening:** large materials ( $\varnothing > 50$  mm), such as construction debris, pieces of rock, pebbles, are removed by a vibrating screen equipped with an iron remover. These materials are generally not contaminated and so on they are sent to the crushing section to recovery on site;
- **Aggregate scrubbing:** the material is loaded at the lower end of an inclined tank and it is transported to the upper end by two rotating shafts, equipped with blades to facilitate the disintegration of it. Silt and clay are removed by the water added to the top of the tank. Impurities and light substances flow out with the water at the lower end of the tank. The pH of the water can be modified to facilitate the solubilization of inorganic compounds, mainly metals;
- **Screening:** the coarse material ( $2 \text{ mm} < \varnothing < 50 \text{ mm}$ ) passes from the top of the scrubber onto a vibrating screener which separates the residual fine material. The coarse material is then further washed to remove the last fine fractions ( $\varnothing < 2$  mm, sand, silt, clay) and it accumulates at the base of the vibrating screener;
- **Sand recovery:** the water containing the fine material is collected in a tank downstream of the vibrating screener, then it is pumped into a hydrocyclone. In the hydrocyclone, the centrifugal force separates the water with silt and clay from the sand; the water with silt and clay flow upwards of the hydrocyclone while the sand comes out from the bottom of it. The wet sand passes through a dispenser that corrects the density of the mixture (60% - 80% of solids) and enters the attrition cells. These cells, thanks to the mixing blades, remove the clay particles and any contaminants on the sand particles. The sands coming from the attrition cells is dried with a vibro dryer. The dry sand mixed with the treated coarse material is transported to the storage platforms.

The Soil Washing plant can process about 200 t/h of material. Actually, the washing is carried out only with water; if the removal of inorganic compounds from the treated material will not be efficient, pH conditioners will be added (strong acids and bases, typically HCl and NaOH).



## 4.2 Feasibility study

The concentration of contaminants in the material to be treated is just above the legal limit, therefore it is assumed that a single wash is sufficient to obtain a material that complies with the legal limits. After the first washing cycle, the treated material will be subjected to a chemical analysis; if it still does not comply with the legal limits, a second washing cycle will be performed.

## 4.3 Water Treatment

The soil washing facility was started up in early March 2022; the information below comes from the remediation project of the area and describes the water treatment plant as planned and not after its construction.

About 350-400 m<sup>3</sup>/h of water to be treated will derive from the Soil Washing plant.

The water treatment plant includes:

- **sedimentation tanks:** the sludge is concentrated, i.e. the silt and clay fall to the bottom of the tank thanks to the addition of a flocculant. The resulting sludge is transferred to a homogenization silo, while the clarified water is returned to the soil washing plant;
- **sludge homogenization silos:** in the silos the sludge is constantly mixed to avoid sedimentation and to maintain the density suitable for the subsequent treatment in the filter press. Milk of lime can be added to improve sludge drainage capacity;
- **filter press:** the filter presses further reduce the water content in the homogenized sludge, which is now ready to be sent to the Stabilization / Solidification plant;
- **chemical-physical treatment of water:** the water from the filter presses (about 15-20 m<sup>3</sup>/h) is transferred to a treatment plant where any dissolved contamination is eliminated by adding additives; the treated water can be used again in the Soil Washing process.

## 4.4 Control parameters

To assess the removal efficiency, the contaminants of concern are measured at the output of any washing cycle.



## 1. Contact details - CASE STUDY: SW n.4

<b>1.1. Name and Surname</b>	Prof. Dr. Domen Lestan
<b>1.2. Country/Jurisdiction</b>	Slovenia
<b>1.3. Organisation</b>	Envit Ltd.
<b>1.4. Position</b>	Assistant assistant manager & CTO of Envit Ltd.
<b>1.5. Duties</b>	Full professor at Biotechnical Faculty, University of Ljubljana
<b>1.6. Email address</b>	info@envit.si domen.lestan@bf.uni-lj.si
<b>1.7. Phone number</b>	<a href="tel:+38659924819">+386 59 924 819</a>

## 2. Site background

### 2.1 History of the site

In the Meza valley in Slovenia, lead - zinc ore has been exploited and processed for more than 300 years. At the end of the 20th century, the Meža River was considered a stream with the highest concentrations of heavy metals in Slovenia. When the mine and processing plants ceased to operate, the direct transfer of heavy metals into the environment has strongly decreased. However, the deposits of poor ore and wastes from ore processing have remained as an indirect source of heavy metal pollution. From those places heavy metals have been washed out into the nearby streams, and carried into the Meža River (Fux, J., & Gosar, M. (2007). Lead and other heavy metals in stream sediments in the area of Meža valley. *Geologija*, 50(2), 347–360.

<https://doi.org/10.5474/geologija.2007.025>).



**Figure 1:** Depicted area of demonstration site 35 x 35 m in Meza Valley, Slovenia.

## 2.2 Geological setting



**Figure 2:** Pasture soil from the upper 30 cm soil layer. Soil was calcareous, contaminated with Pb, Zn and Cd by floods of Meza River.

<b>pH (CaCl<sub>2</sub>)</b>	<b>7.28</b>
<b>Org. matter (%)</b>	<b>5.3</b>
<b>C/N</b>	<b>10.7</b>
<b>P<sub>2</sub>O<sub>5</sub> (mg 100 g<sup>-1</sup>)</b>	<b>7.5</b>
<b>K<sub>2</sub>O (mg 100 g<sup>-1</sup>)</b>	<b>4.8</b>
<b>CaCO<sub>3</sub> (%)</b>	<b>21</b>
<b>Sand (%)</b>	<b>59.2</b>
<b>Silt (%)</b>	<b>32.3</b>
<b>Clay (%)</b>	<b>8.5</b>
<b>CEC(mmol<sub>c</sub>/100g)</b>	<b>18.48</b>

**Figure 3:** Standard pedological properties of soil.

## 2.3 Contaminants of concern

Pseudo total concentrations of contaminated soils with Pb, Zn (upper 30 cm layer), flooded by Meza River.

1. Pb  $1734 \pm 78$
2. Zn  $3313 \pm 178$
3. Cd  $24 \pm 1$

In situ investigations using a portable X-ray fluorescence spectrophotometer (XRF, see below **Figure 4**) showed a strong concentration gradient of Pb contamination from the riverbank.

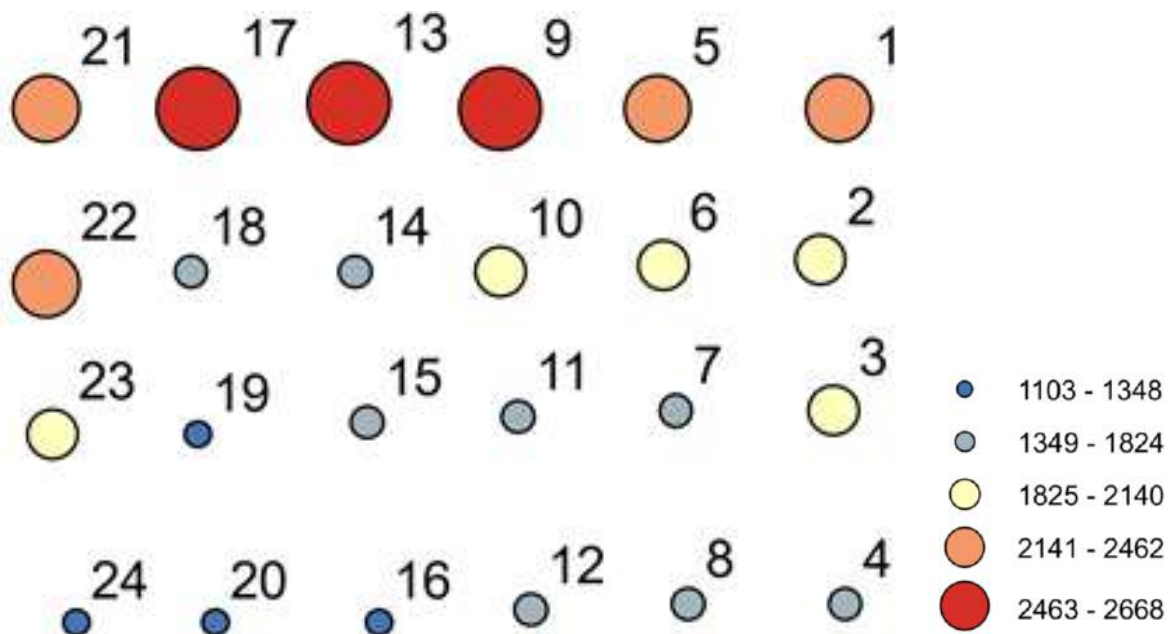

**Figure 4:** Average soil Pb concentration (0-30 cm, mg kg<sup>-1</sup>) in site 35m x 35m.

## 2.4 Regulatory framework

In decree on limit values, alert thresholds and critical levels of dangerous substances into the soil (Uradni list RS, št. [68/96](#) in [41/04](#) – ZVO-1) from Slovenia, this soil are contaminated because concentration of all three toxic elements (Pb, Zn and Cd) are exceeding legislation value for non-contaminated soil (Pb > 100, Zn ≥ 300 and Cd ≥ 2 mg kg<sup>-1</sup>). Plants that are grown on that soil are also exceeding legislation value which are set by COMMISSION REGULATION (EC) No 1881/2006 Setting maximum levels for certain contaminants in foodstuffs.

### 3. Pilot-scale application in field

#### 3.1 Soil washing system

Washing solution is made by 100 mM EDTA (65% of calcium form, 20% of acid form, 15 % of sodium form). Soil/water ratio is 1:1. Soil are after filtration in filter press 3 times rinsed with recycled solution from previous batch and at the end with fresh water. Fresh water was added to the system to compensate for the losses of process water: due to the moisture difference between the soil entering and leaving the process, water lost with the wet solid wastes, and the hydration of the quicklime (*Figure 5*).

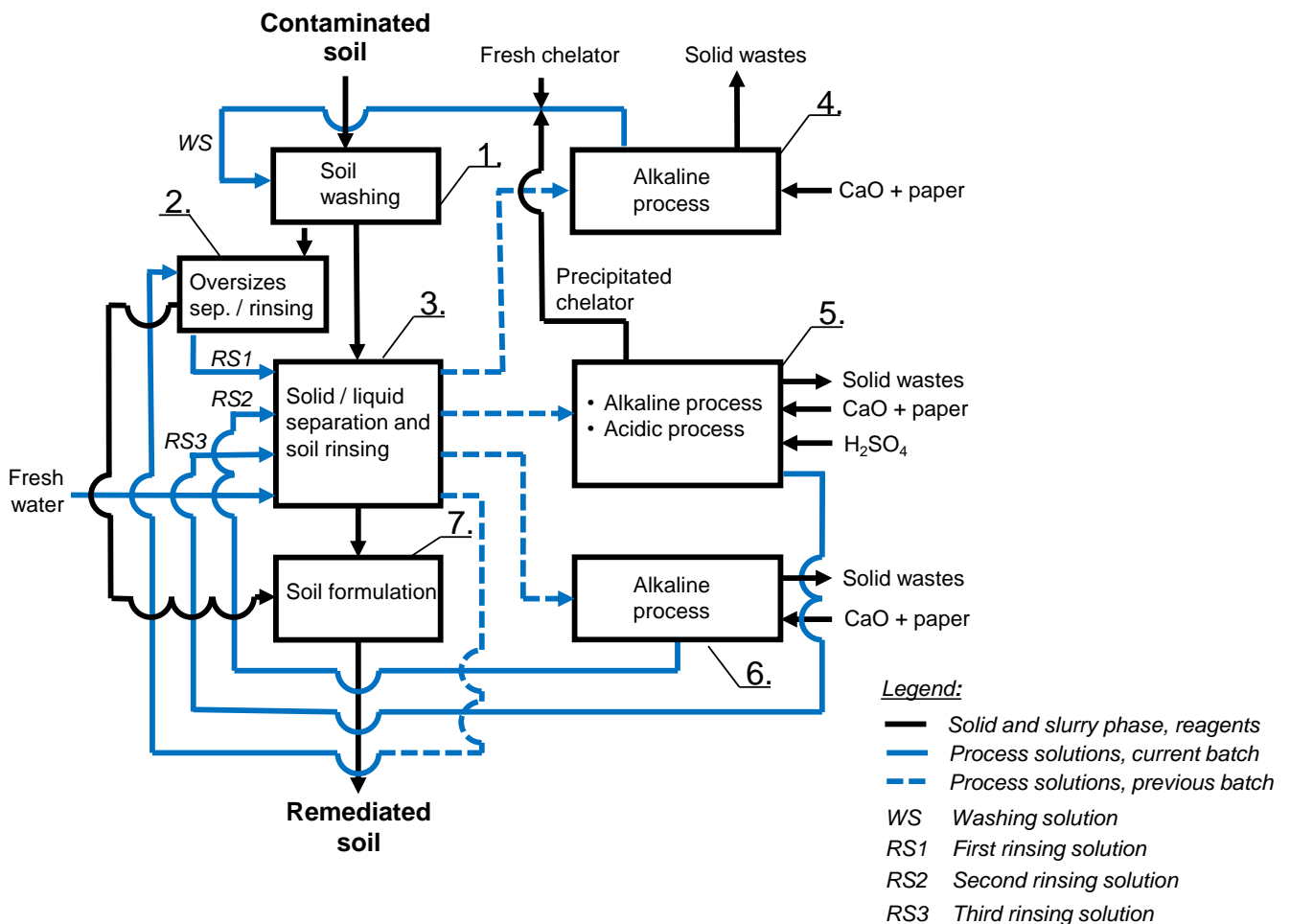

**Figure 5:** The flowchart of ReSoil® soil remediation process with material mass flows per batch.

The used RS1 (uRS1) from the previous batch is not treated; it issued directly as RS1 in the current batch. The used WS (uWS), used RS2 (uRS2), and used RS3 (uRS3) are treated by alkalization with quicklime (CaO, pH > 12, 30 min) to remove toxic metals and recycle the chelator in the form of Ca salt (steps 4, 5, 6). The uWS, uRS3 and uRS2 are treated with waste paper for alkaline adsorption of toxic metals. The waste paper is applied into the

uRS2 in step 6 and separated from the solution (RS2) by a filter press after 10 min of adsorption reaction. The paper from step 6 is reused in the same way, first in step 5 and then in step 4. Solid waste: hydrated lime from step 4, 5, 6 and the final paper enriched with toxic metals from step 4 is removed from the process solutions by filtration and disposed of safely. The uRS1 is acidified to pH 2 in step 5 by adding 96% H<sub>2</sub>SO<sub>4</sub> to precipitate and recover (120 min reaction time) the remaining chelator in acidic form by filter press. The recycled WS is then prepared by adding acidic and fresh chelator to compensate for the loss of chelator in the process: the chelator is removed with the waste and bound to ZVI in the soil solid phase.

ReSoil<sup>®</sup> is designed as a close loop process (circular economy), everything is designed to have no negative impact on the environment, everything is emission free (no leakage, no gaseous emissions, only solid waste). ReSoil<sup>®</sup> enables dual action: removal of heavy metals by EDTA and auxiliary extractants & immobilization of residual pollutants by zero-valent Fe (ZVI) and auxiliary adsorbents.



**Figure 6:** Scheme of ReSoil<sup>®</sup> system.



### 3.2 Feasibility study

Fraction share of toxic elements are presented in **Figure 7**.

Pb is mainly bound to carbonates and organic matter fraction, Zn is mainly bound to residual and organic matter fraction, Cd is mainly bound to carbonates and organic matter fraction. Soil washing was able to remove toxic metals from more labile fraction. Toxic metals which are strong bound to soil particles are not mobile and therefore do not pose a treat for environment and human. With remediation we were able to reduced Pb, Zn and Cd for 68%, 28% and 50%.

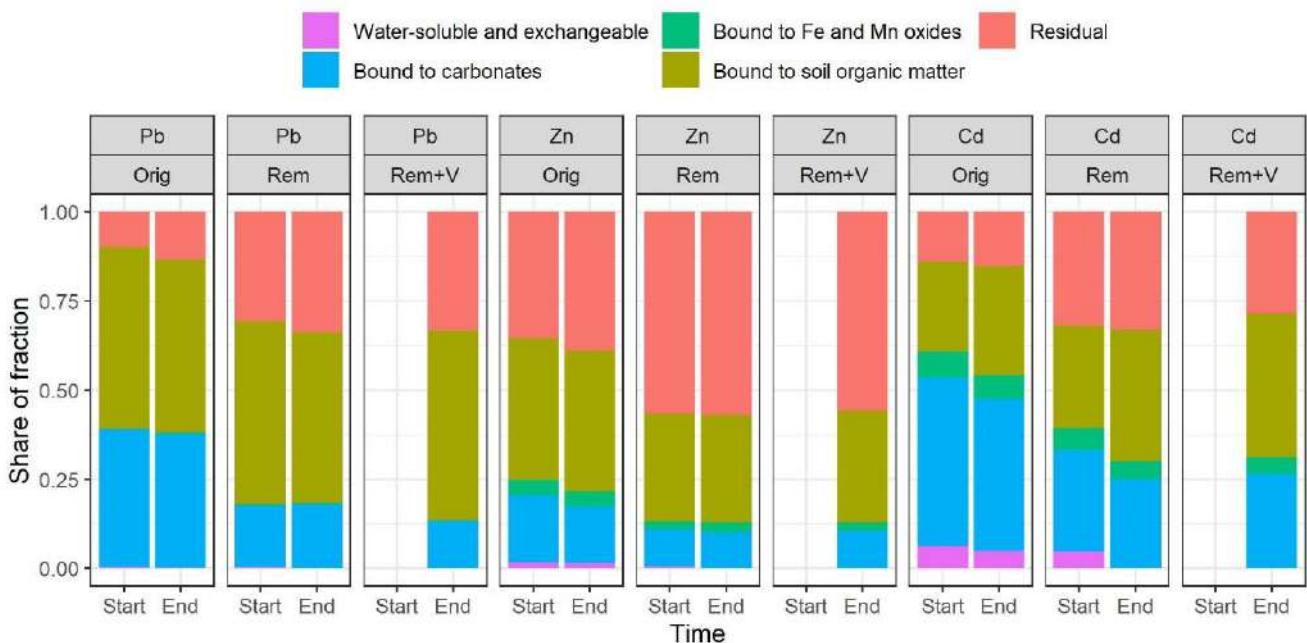

**Figure 7:** Share of heavy metal fractionation.

The important parameter is difference between stability of EDTA-toxic metals complex and stability of chemicals form of toxic metals present in soil. The toxic metals which could not be removed by ReSoil® process are biological and chemical unattainable. Most of toxic metals after remediation is present in soil as soil minerals, which are inert and non-toxic.

Important parameter is also soil functionality and purpose to use soil as plant substrat after remediation:

Common biological indicators of soil quality (**Figure 8**) were used to assess soil functioning. Most of microbialactivity in soil was similar then in original or recovered in 1 year of gardening. The results of our experiments clearly show that functional arbuscular mycorrhiza can be established without inoculations in remediated soils under environmental conditions. Soil washing has minor effect on standrad soil pedological properties (**Figure 8**).

<b>Calcareous soil</b>		
	<i>Original</i>	<i>Remediated</i>
<b>pH (CaCl<sub>2</sub>)</b>	7.28	7.67
<b>Org. matter (%)</b>	5.3	5.6
<b>C/N</b>	10.7	11.9
<b>P<sub>2</sub>O<sub>5</sub> (mg 100 g<sup>-1</sup>)</b>	7.5	11.1
<b>K<sub>2</sub>O (mg 100 g<sup>-1</sup>)</b>	4.8	6.3
<b>CaCO<sub>3</sub> (%)</b>	21	19
<b>Sand (%)</b>	59.2	37.2
<b>Silt (%)</b>	32.3	51.9
<b>Clay (%)</b>	8.5	10.9
<b>CEC(mmol<sub>c</sub>/100g)</b>	18.48	18.23

**Figure 8:** Standard pedological analysis of soil.

### 3.3 Water Treatment

ReSoil® soil washing process does not produce waste water. All solution which are used are recycled in a closed process loop.

### 3.4 Control parameters

Field monitoring and sampling program that will adequately monitor the effectiveness of the treatment in three dimensions.

- Leaching of EDTA and metal complex from remediated soil.
- Checking soil rinsing efficiency in large filter press.

## 4. Full-scale application

### 4.1 Soil washing system

In ReSoil® (**Figure 9**) the soil is excavated and grid sieved to remove oversize material.

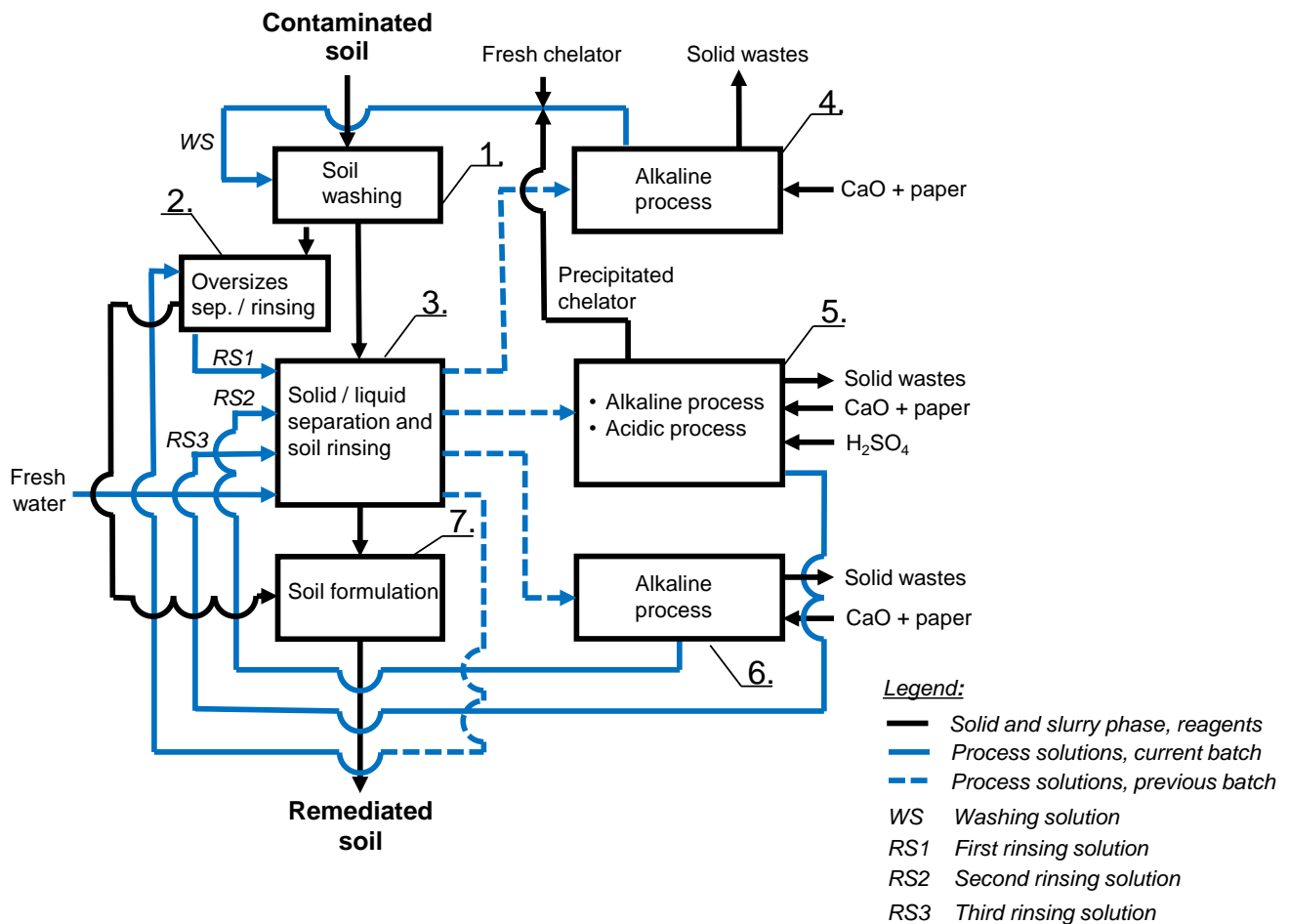
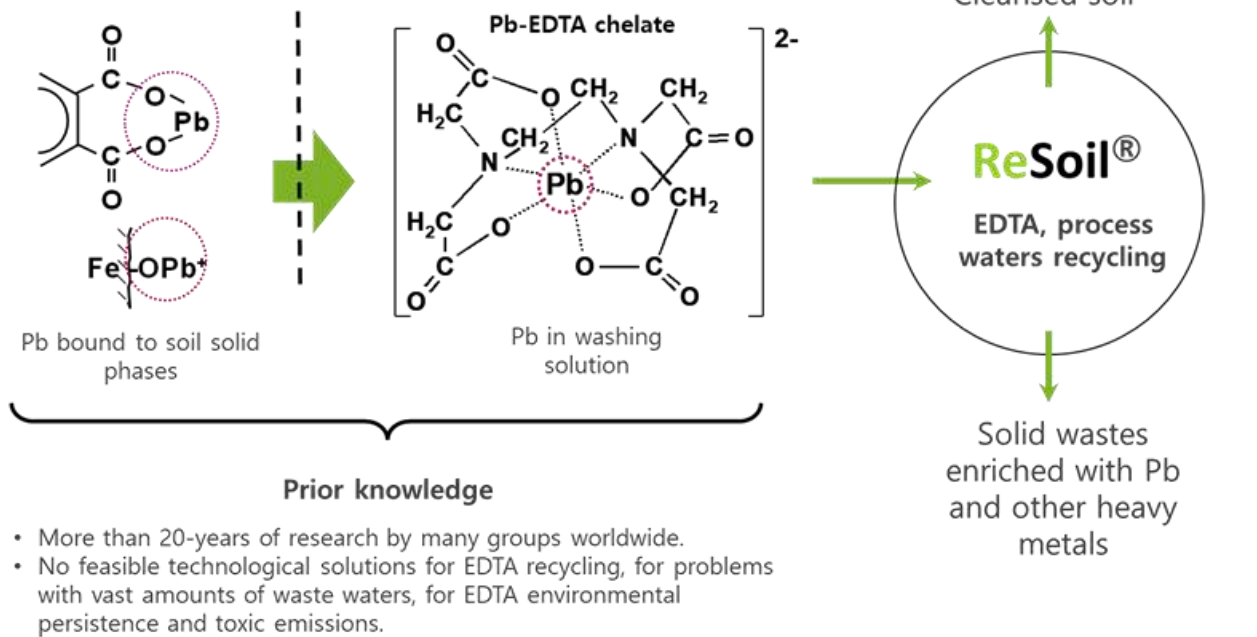

**Figure 9:** The flowchart of ReSoil® soil remediation process with material mass flows per batch.

Soil is washed in mixer to remove Pb and other toxic metals (Zn, Cd). Washing solution contain ethylenediamine tetraacetate (EDTA), as washing agent. The mechanisms of contaminants removal are explained bellow (**Figure 10**).

## ReSoil® technology – Pb example

EDTA-based soil-washing efficiently remove Pb and other heavy metals from soil:



**Figure 10:** Example of successful Pb removal with ReSoil® technology.

In a downstream process, the washed soil will be rinsed in a filter press with three consecutive rinsing solutions recycled from the previous batch and with fresh water to compensate for water losses (Figure 2).

Washing solution is made by EDTA (65% of calcium form, 20% of acid form, 15 % of sodium form). Soil/water ratio is 1:1. Soil are after filtration in filter press 3 times rinsed with recycled solution from previous batch and at the end with fresh water. Fresh water was added to the system to compensate for the losses of process water (**Figure 12**): due to the moisture difference between the soil entering and leaving the process, water lost with the wet solid wastes, and the hydration of the quicklime.



**Figure 12:** Stationary ReSoil® facility with capacity of 6 t/day constructed under [LIFE+ programme](#).

The flowchart of ReSoil® soil remediation process did not change between pilot and full-scale application. The used RS1 (uRS1) from the previous batch is not treated; it issued directly as RS1 in the current batch. The used WS (uWS), used RS2 (uRS2), and used RS3 (uRS3) are treated by alkalization with quicklime ( $\text{CaO}$ ,  $\text{pH} > 12$ , 30 min) to remove toxic metals and recycle the chelator in the form of Ca salt (steps 4, 5, 6). The uWS, uRS3 and uRS2 are treated with waste paper for alkaline adsorption of toxic metals. The waste paper is applied into the uRS2 in step 6 and separated from the solution (RS2) by a filter press after 10 min of adsorption reaction. The paper from step 6 is reused in the same way, first in step 5 and then in step 4. Solid waste: hydrated lime from step 4, 5, 6 and the final paper enriched with toxic metals from step 4 is removed from the process solutions by filtration and disposed of safely. The uRS1 is acidified to  $\text{pH} 2$  in step 5 by adding 96%  $\text{H}_2\text{SO}_4$  to precipitate and recover (120 min reaction time) the remaining chelator in acidic form by filter press. The recycled WS is then prepared by adding acidic and fresh chelator to compensate for the loss of chelator in the process: the chelator is



removed with the waste and bound to ZVI in the soil solid phase. Process is made in closed cycle loop (described above). In demonstrational plant (**Figure 10**) we are able remediated 1 ton of soil per day, with possibility to work 6 ton per day.

## 4.2 Feasibility study

The feasibility of ReSoil® novel soil remediation technology can be made in small scale. Only 1kg of soil is needed to make pre-treatment experiment to check efficiency of EDTA (concentration selection of EDTA).

## 4.3 Water Treatment

ReSoil® soil washing process does not produce waste water. All solution which are used are recycled in a closed process loop.

## 4.4 Control parameters

To assess the removal efficiency, the contaminants of concern are measured at the output of any washing cycle. Remediated soil water extraction test is used for assessing soil leaching suitability, by measuring toxic metals and EDTA concentration in extracts.



## 5. Results

### 5.1 Removal rate

The average concentrations of toxic metals were  $1854.0 \pm 69.4$  mg/kg Pb,  $3833.2 \pm 77.8$  mg/kg Zn and  $21.2 \pm 0.7$  mg/kg Cd in the original soil and  $545.1 \pm 9.6$  mg/kg Pb,  $2743.4 \pm 69.4$  mg/kg Zn and  $9.9 \pm 0.2$  mg/kg Cd in the remediated soil. On average, remediation reduced the concentration of Pb, Zn and Cd by 71, 28 and 54%, respectively. Zn removal was characterized by lower extractability, likely due to the predominant Zn association with non-labile soil fractions.

Most of the Pb in original soil was in carbonate, organic, and residual fractions. Washing with EDTA removed on average 86% of Pb from the carbonate fraction and 69% of Pb from the organic fraction. For this reason, the share of Pb in the residual fraction increased, although the total Pb concentration in the residual fraction decreased slightly. EDTA was apparently able to extract a small amount of Pb from the solid matrix of soil minerals as well. Up to 40% of the Zn in original soil was present in the residual fraction. This high proportion of highly non-labile Zn explains the low extractability with EDTA. Nevertheless, EDTA efficiently reduced the water-soluble and exchangeable fraction of Zn by 75%. Zn was also removed from the carbonate, oxide and organic soil fractions by 60%, 59% and 44%, respectively.

Most of Cd was present in the carbonate and organic soil fraction. However, compared to Pb and Zn, Cd was more evenly distributed among the fractions. Similar to Pb and Zn, remediation efficiently removed 67% of Cd from the water-soluble and exchangeable fractions. In addition, 70%, 59% and 44% of the Cd was removed from the carbonate, oxide and organic fractions, respectively.

Overall, the sequential extraction results suggest that most of the toxic metals remaining in the soil after ReSoil® were allocated in non-labile soil fractions, making them less accessible and hazardous.

## 6. Post treatment and/or Long Term Monitoring

### 6.1 Post treatment and/or Long Term Monitoring

We conducted raised (demonstrational) bed experiments (**Figure 13**). Demonstrational beds filled with homogenised remediated soil are constructed as lysimeters with drainage system for collection / sampling of soil leachates. The purpose of lysimeter beds was to demonstrate through monitoring that ReSoil® process does not produce toxic emissions / leachates e.g. prevents emissions into environment. Fast growing, all season plant species e.g. buckwheat were used. Lysimeters are installed in beds for easy to sample leachate collection: toxic metals and EDTA in leachates were measured.

We monitored different parameters as:

- leaching of toxic metals and EDTA
- soil physical properties
- soil biological properties (microbial activity and mycorrhizae)
- plant growth and toxic metal accumulation



**Figure 13:** Vegetable garden with remediated soil as a concept of post treatment and/or long term monitoring. The growth of leek, lettuce and carrots is depicted.





## 7. Additional information

### 7.1 Lesson learnt

#### 1) methodology and procedures

Procedure was very effective, there was no problems with recycling solutions. Selected equipment in ReSoil demonstration on large scale worked well. There is some room for improvement of reduction dangerous waste after solutions recycling.

#### 2) technical aspects

Because of strong concentration gradient it is important to good mixed soil before treatment to get consistent performance of remediation process.

#### 3) legislative, organizational aspects

Legislative is only made for whole toxic metals concentration in soil. However, after ReSoil® remediation soil with toxic metals concentration above legislative limits are safe because all potential mobile fraction of toxic metals were removed. From organizational aspect we can say that it is very important to use right dissemination of the procedures when presenting innovative remediation technology to the lay public. If local people are scared of your process (soil washing with EDTA) it is hard to work and cooperate in that environment.

### 7.2 Additional information

Toxic metal fractionation, more mobile fraction better success of remediation.

## Glossary of Terms

Term (alphabetical order)	Definition
ZVI (Fe <sup>0</sup> )	Zero valent iron
EDTA	ethylenediamine tetraacetate
H <sub>2</sub> SO <sub>4</sub>	Sulfuric acid
CaO	Quick lime



## 1. Your contact details - CASE STUDY: SW n.5

<b>1.1. Name and Surname*</b>	Alessia Arelli
<b>1.2. Country/Jurisdiction</b>	Italy
<b>1.3. Organisation</b>	DICAM, University of Bologna - Italy
<b>1.4. Position</b>	Official - Soil Protection Department - Geological Survey of Italy - ISPRA - Italian National Institute for Environmental Protection and Research
<b>1.5. Duties</b>	PhD student (2013 – 2015) – DICAM, University of Bologna - Italy
<b>1.6. Email address</b>	Alessia.arelli@isprambiente.it
<b>1.7. Phone number</b>	0039-3406262512

## 2. Site background

### 2.1 History of the site

- **Oil spills**

Hydrocarbons contamination of coastal environments due to accidental oil spills and activities related to the petrochemical industry is of high concern. Ocean contamination is due by several sources including the river releases, natural resource exploitation over the oil spills pollution by ships and oil tankers [1]. Was estimated that every year nearly 4 million tons of oil are globally spilled in the sea [2] determining a strong impact on the coastal environment.

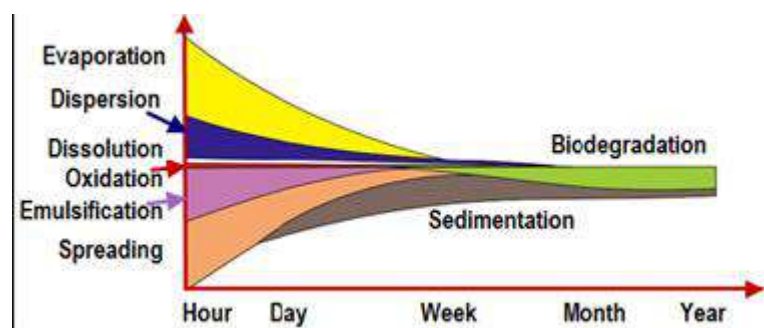
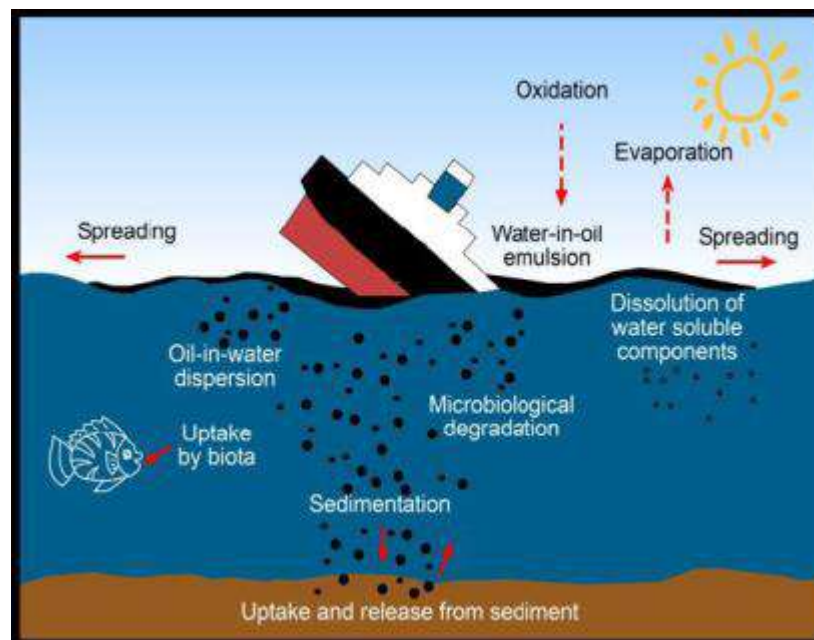

[1] Fingas M (2011) Introduction to Oil Chemistry and Properties. In: Fingas M (ed) Oil Spill Science and Technology, DOI:10.1016/B978-1-85617-943-0.10003-6

[2] Cohen MA (2013) Water Pollution from Oil Spills. In: Encyclopedia of Energy, Natural Resource and Environmental Economics, DOI:1016/B978-0-12-375067- 9.00094-2



## 2.2 Geological setting

- **Beach sand contamination**

A beach sand collected from the shore near Ravenna (northern Italy) was used. From the screening of the sands (<2mm) the matrix was classified as sand, based on the USDA classification. The organic carbon content was estimated <1% (determination of organic carbon with the Sprinter-Klee method), given in agreement with the sandy matrix; and the pH  $\approx$ 7.2 (potentiometric method). The sand was contaminated in the laboratory with IFO180 (Intermediate Fuel Oil 180) marine fuel by Shell, a mixture of 98% of residual oil and 2% of distillate oil obtained from the heavy and medium fractions of crude oil. Briefly, IFO180 fuel was dissolved at 40 g/L in hexane: dichloromethane (1:20). Different volumes of the fuel solution were then added to the sand and thoroughly mixed, followed by complete solvent evaporation and weathering of oil hydrocarbons, to obtain sand samples contaminated at different final concentrations in the range 0.5 - 20 g/kg.

## 2.3 Contaminants of concern

- **IFO180, marine fuel, by Shell is regulated from ISO8217.**

IFO180 is composed of 80-92% by high viscosity residues and 5-20% by distillates (IMO, <http://www.imo.org/>). The chemical composition of the residue is quite variable, usually IFO180 is characterized by long chains of aliphatic hydrocarbons from C10 to C40, cycloalkanes and aromatics. These constitute the non-polar fraction. Furthermore, the refining residue contains asphaltenes, present in the solid state and slightly hydrophobic. Resins and asphaltenes also consist of heterocyclic compounds with sulphur, nitrogen and oxygen representing the polar and heaviest fraction of IFO180. There are also traces of metals (vanadium). In IFO180 there are polycyclic aromatic hydrocarbons (PAHs), typically 1.5%, and traces of benzo [a] pyrene at 0.2% (Material Safety Data Sheet Fuel Oil, Tesoro 2012). Due to the high viscosity of IFO180, this product is suitably pre-treated, the sample untreated is dissolved in a hexane solution: dichloromethane (1:20) overnight, under a hood; in this way the product is treatable and loses the most volatile fraction of hydrocarbons, simulating the natural weathering process that undergoes an oil stain when it is released into the sea and reaches the coasts.



## 2.4 Regulatory framework

The surfactant aided ex situ washing technology has been proposed for cleaning up oil-contaminated sands; however, while the use of synthetic commercial surfactants at concentrations well above their critical micelles concentrations (CMCs) has been shown to effectively remove hydrophobic pollutants from contaminated soils [3], the environmental compatibility of such remediation practice is limited due to the toxicity, recalcitrance and persistence of such synthetic surfactants in the washed soil. The opportunity to use cheap, non-toxic, and biodegradable pollutant-mobilizing agents in this process has been previously investigated for soils contaminated by polycyclic aromatic hydrocarbons [3], petroleum hydrocarbons [4,5] and chlorinated aromatics [6,7]. So, in this context was tested the effectiveness of biogenic, non toxic and biodegradable pollutant-mobilizing agents or surfactants in the washing of oil-contaminated beach sands. this approach is allowed by the Italian law which promotes the use of bio-sustainable substances in contaminated sites remediation

[3] Von Lau E, Gan S, Ng HK, Poh PE (2014). Extraction agents for the removal of polycyclic aromatic hydrocarbons (PAHs) from soil in soil washing technologies. *Environ Pollut* 184:640.

[4] Singh AK, Cameotraet SS (2013). Efficiency of lipopeptide biosurfactants in removal of petroleum hydrocarbons and heavy metals from contaminated soil. *Environ Sci Pollut Res* 20:7367.

[5] Hernández-Espriú A, Sánchez-León E, Martínez-Santos P, Torres LG (2013). Remediation of a diesel-contaminated soil from a pipeline accidental spill: enhanced biodegradation and soil washing processes using natural gums and surfactants. *J Soils Sediments* 13:152.

[6] Berselli S, Benitez E, Fedi S, Zannoni D, Medici A, Marchetti L, Fava F (2006). Development and Assessment of an Innovative Soil-Washing Process Based on the use of Cholic Acid-Derivatives as Pollutant-Mobilizing Agents. *Biotechnology and Bioengineering* 93:761

[7] Berselli S, Milone G, Canepa P, Di Gioia D, Fava F (2004). Effects of Cyclodextrins, Humic Substances, and Rhamnolipids on the Washing of a Historically Contaminated Soil and on the Aerobic Bioremediation of the Resulting Effluents. *Biotechnology and Bioengineering* 88:11.

## 3. Pilot-scale application in field

### 3.1 Soil washing system

- Biosurfactant and mobilizing agents investigated in sand washing**

A number of biogenic mobilized agents commercially available at low cost were used in washing tests, namely: two soy lecithin commercial products: SOLEC™ F (SL-1) by Solae Italia s.r.l. and TEXTROL™ F (SL-2) having hydrophobic/lipophilic balances of 7 and 4, respectively; a more hydrophilic (hydroxypropyl-β-cyclodextrin, HPB-CD) and a more hydrophobic (randomly methylated β-cyclodextrin, RAMEB) technical grade cyclodextrins mixture, both provided by Amaizo-Cerestar (USA); four commercial cleaning products based on plant extracts (SuperSolv Safety Solvent, SC1000, Aircraft Cleaner, OmniBrite Acid Cleaner, all provided by BioBased Europe) and bovine bile acids (BB), provided by ICE srl, Italy, that mainly contains cholic acid. In addition, three microbial surfactants were employed, namely rhamnolipids (RL) sophorolipids (SR) and surfactin (SF). Finally, the synthetic surfactant Triton X-100 (TX) was used as reference, given its high hydrocarbons removal efficiency in the washing of soils contaminated by petroleum hydrocarbons.

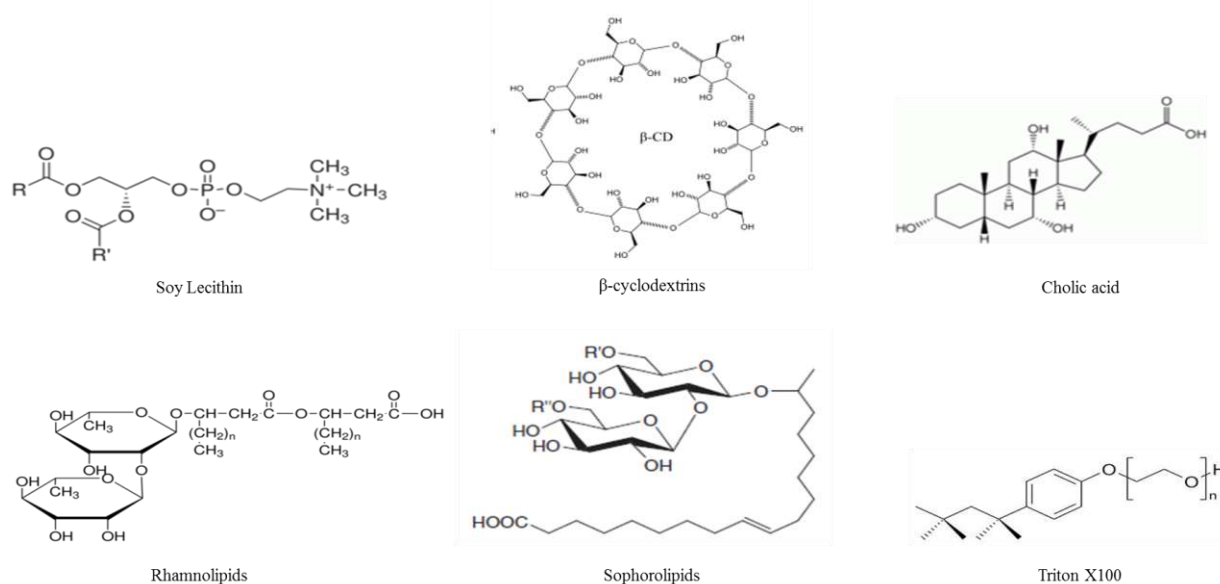

**Fig. 1** Agents of plants and animal origin (Soy Lecithin – SL-1 e SL-2; β-cyclodextrin – HPB-CD e RAMEB) and microbial surfactants (Rhamnolipids – RL; Sophorolipids - SR) compared to Triton X100

- Preliminary screening of the agents in the washing of oil-contaminated beach sands**

In the first phase of the study, washing tests were performed on 50 g of contaminated

beach sand with 350 mL of a water solution (sand:water ratio equal to 1:7) of each agent, in 1 L shaken reactors for 48h at room temperature under mixing at 150 rpm. All agents were used at 1% (w/v) concentration in the water phase, except for RL and SR that were employed at 0.1 % (w/v), due to their very low critical micelle concentration (0.1-0.2 g/L). The washing process was monitored after 4, 8, 24 and 48 hours. the most promising agents selected in the first phase, was SL-1, HPB-CD and SR in terms of hydrocarbons removal %, HC.



- **Sampling, extraction and analytical methods**

At each sampling during the washing procedure, an aliquot of homogeneous sand suspension was withdrawn from the reactor and sand allowed to settle. After removal of the water phase, sand was air dried overnight and hydrocarbons batch extracted overnight from 5 g of sand with 5 mL of the solvent mixture hexane:acetone (1:1). Batch extraction was assisted with ultrasonication for 5 min before and after overnight mixing. Qualitative and quantitative analysis of IFO180 fuel hydrocarbons (total hydrocarbons and n-alkanes) in the organic extracts was performed with an Agilent Technologies gas-chromatograph 6890N equipped with a HP-5 capillary column and a flame ionization detector (Hewlett-Packard Co., Palo Alto, CA, USA) under the analytical conditions described in Zanaroli et al. [8]. Total hydrocarbons were quantified, previous 12 points IFO180 calibration curve in concentration range 0.1-20 g/l ( $R^2 \geq 0.99$ ). N-alkanes were quantified, previous 7 points standard mixture of n-C10 to n-C40 alkanes calibration curve in concentration range 0.01-50 ppm ( $R^2 \geq 0.99$ ).

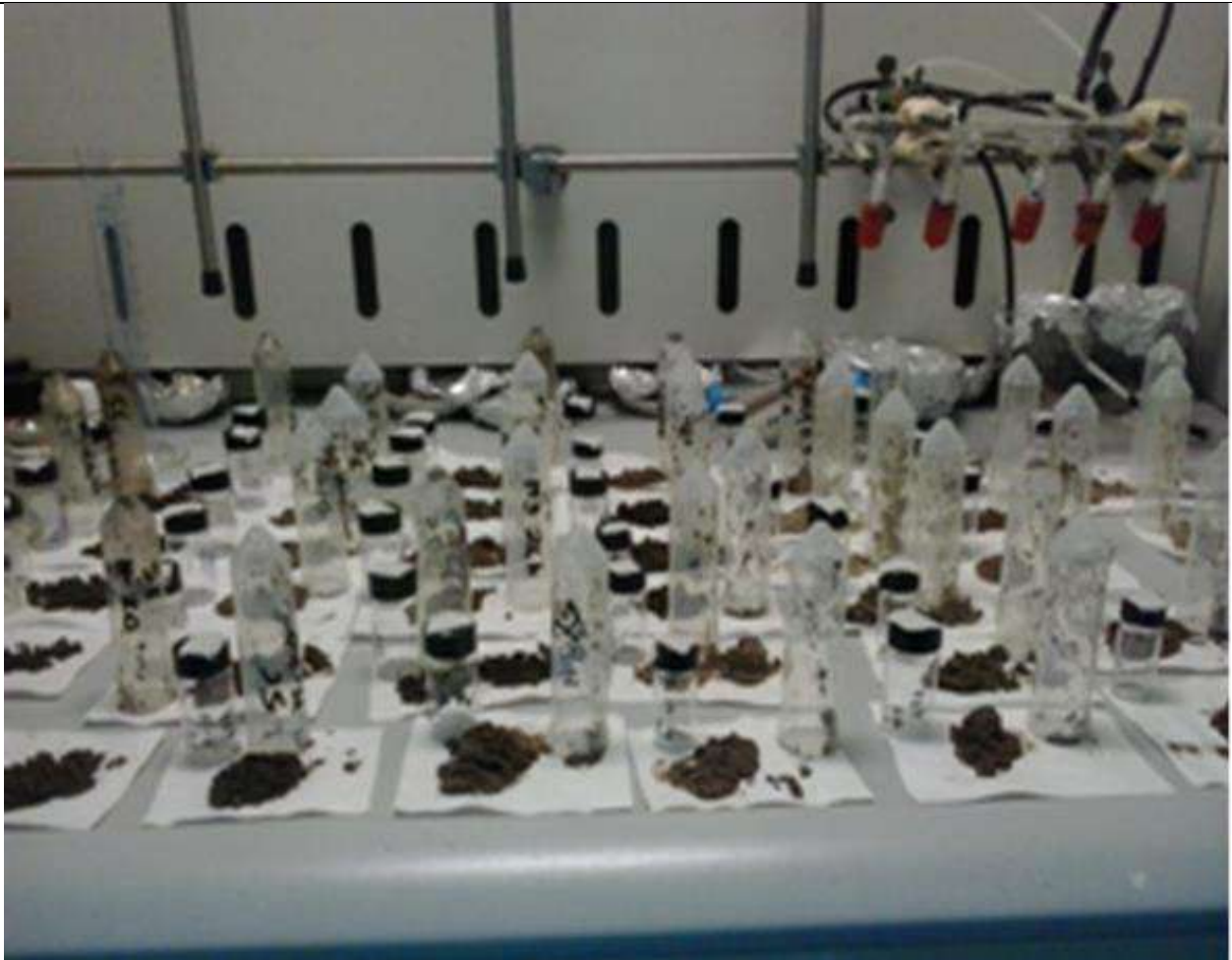

[8] Zanaroli G, Di Toro S, Todaro D, Varese GC, Bertolotto A, Fava F (2010). Characterization of two diesel fuel degrading microbial consortia enriched from a non acclimated, complex source of microorganisms. MICROBIAL CELL FACTORIES, vol. 9, pp. 10.





## 3.2 Feasibility study

- **Preliminary screening of the agents and selection of the most promising ones**

Total hydrocarbons removals of  $71.2 \pm 4.3\%$  and  $82.9 \pm 0.7\%$  and n-alkane removals of  $57.4 \pm 4.3\%$  and  $76.0 \pm 0.5\%$  were attained with the synthetic surfactant Triton X-100 (Triton X) after 4h and 48h of treatment, respectively. Comparable removals of both total hydrocarbons ( $68.2 \pm 1.5\%$  and  $83.2 \pm 0.3\%$  after 4 and 48 hours, respectively) and n-alkanes ( $56.0 \pm 1.7\%$  and  $79.1 \pm 0.5\%$  after 4 and 48 hours, respectively) were obtained with the more hydrophilic soy lecithin product (SL-1), whereas remarkably lower removals of both total hydrocarbons and n-alkanes were attained with the more hydrophobic soy lecithin (SL-2) after the same treatment time. Similarly, remarkably higher removals of total hydrocarbons and n-alkanes were obtained with the more hydrophilic cyclodextrins mixture (HPB-CD) compared to the more hydrophobic one (RAMEB-CD). Removals obtained with the best performing cyclodextrin (HPB-CD) were approximately 70% of those obtained with TX and SL-1 for total hydrocarbons ( $50.9 \pm 0.5\%$  and  $57.2 \pm 2.9\%$  after 4 and 48 hours, respectively) and 80-90% of those obtained with TX and SL-1 for n-alkanes ( $53.9 \pm 3.2\%$  and  $64.2 \pm 5\%$  after 4 and 48 hours of washing, respectively). All other plant derived products and BB exhibited both total hydrocarbons and n-alkanes removal efficiencies remarkably lower than that of TX. Among the two microbial surfactants, SR allowed to obtain higher removals of both total hydrocarbons ( $57.3 \pm 1.0\%$  and  $63.2 \pm 1.3\%$  after 4 and 48 hours, respectively) and n-alkanes ( $36.8 \pm 1.0\%$  and  $76.8 \pm 9.3\%$  after 4 and 48 hours, respectively) than RL. Although both microbial surfactants were applied at concentrations apparently well above their CMC, the typically lower CMC of SR (approximately one half of that of RL, i.e., approximately 0.1 g/L vs 0.2 g/L), might explain its higher hydrocarbons removal efficiency[9].

**Overall, under the washing conditions used in these preliminary tests, only SL-2 exhibited hydrocarbons removals comparable to that of TX, and HPB-CD and SR hydrocarbons removals slightly lower (70% or more) than that of TX. These agents were therefore selected for the second phase of the study aiming at optimizing the washing conditions.**

[9] Arelli A., Zanaroli G., Fava F (2014). Washing of oil-contaminated beach sands aided with biogenic, non toxic and biodegradable pollutant-mobilizing agents and microbial surfactants, in: Ecomondo 2014 - Green Economy: ricerca, innovazioni e azioni nel mediterraneo, RECLAIM EXPO, Maggioli Editore, pp. 528-533.

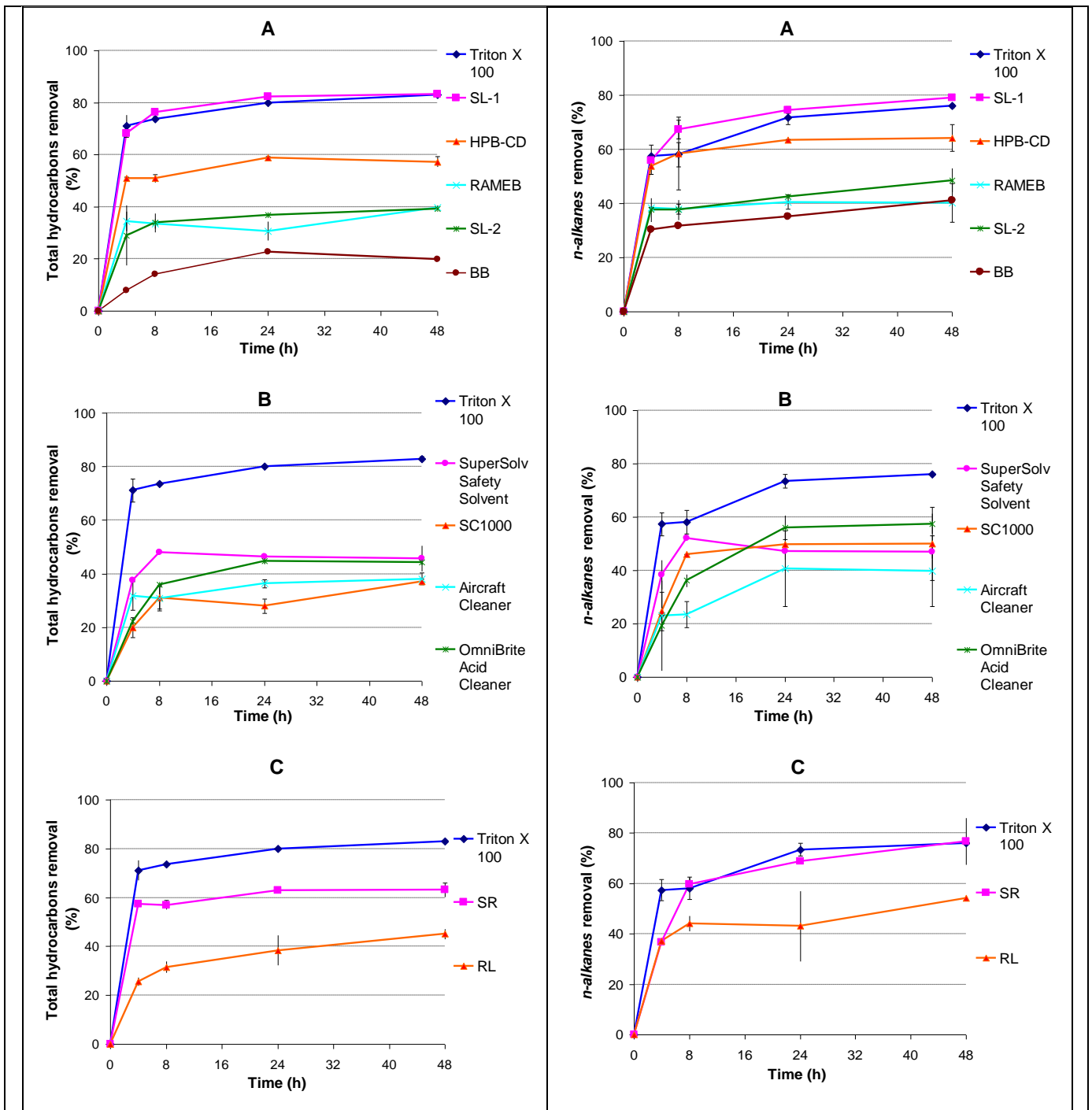

**Fig. 2** Total hydrocarbons removal ( $C/C_0$ ) obtained with agents of plant and animal origin (A), cleaning products (B) and microbial surfactants (C) compared to Triton X-100

**Fig. 3** n-alkanes removal ( $C/C_0$ ) obtained with agents of plant and animal origin (A), cleaning products (B) and microbial surfactants (C) compared to Triton X-100.

### 3.3 Water Treatment

- **Mass balance (HC).**

About water phase, was only verified the mass balance, to support the results obtained in the first experimental phase, relating to the removal percentages in terms of total hydrocarbons. For each tested surfactant, the aqueous wastewater was sampled during the washing treatment, in a quantity proportional to the sands extracted. Below are reported the results of the percentage mass balance observed between HC present in the sands and in the aqueous wastewater, in the samples taken after 4, 8, 24, 48 hours of washing for the agents of animal and vegetable origin compared with TX.

The results appear satisfactory; the mass balances mostly fall within the range of 100 - 120%.

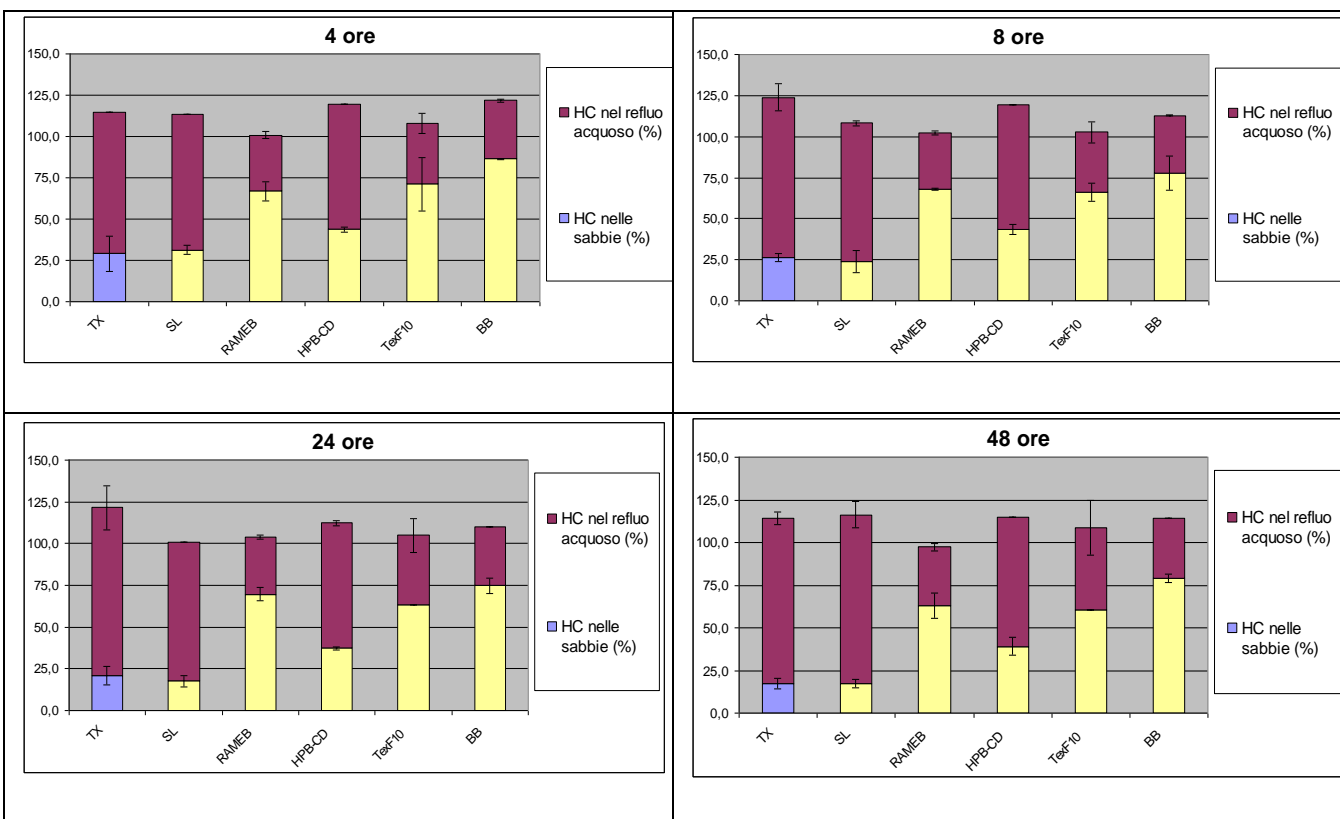

### 3.4 Control Parameters

- **Control parameters and their optimization by ANOVA approach**

In the second phase of the study, the parameters mainly affecting the washing efficiency and the optimal washing conditions were investigated for the most promising agents selected in the first phase, namely SL-1, HPB-CD and SR, and for TX and the agent-free control. The following operating parameters were considered: surfactant concentration (% w/v), water/sand ratio (v/w), mixing rate (rpm), IFO180 concentration (g/kg). The statistical design of experiment (DoE) based on the Central Composite Design (CCD) was used for the above 4 parameters (except surfactant concentration in the case of the surfactant-free control) using 3 levels and 1 response (hydrocarbons removal %, HC). For the experimental design, ANOVA and identification of optimal washing parameters, the Design Expert software was used [10].

**DoE (CCD) – 4 parameters (A, B, C, D) 3 levels (-1; 0; +1)**

*A – Sur. conc. (g/100 ml)*

*B – water/sand ratio (ml/g)*

*C – mixing rate (rpm)*

*D – IFO180 conc. (g/kg)*

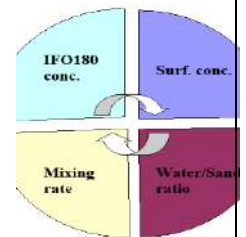

**i)**

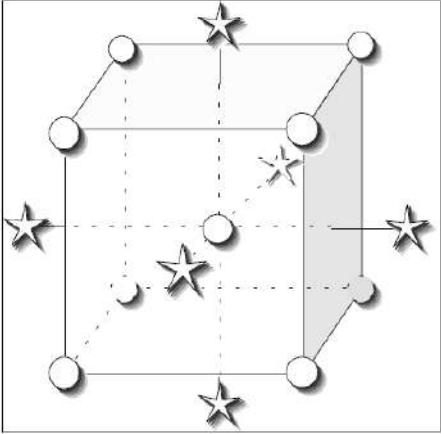

**ii)**

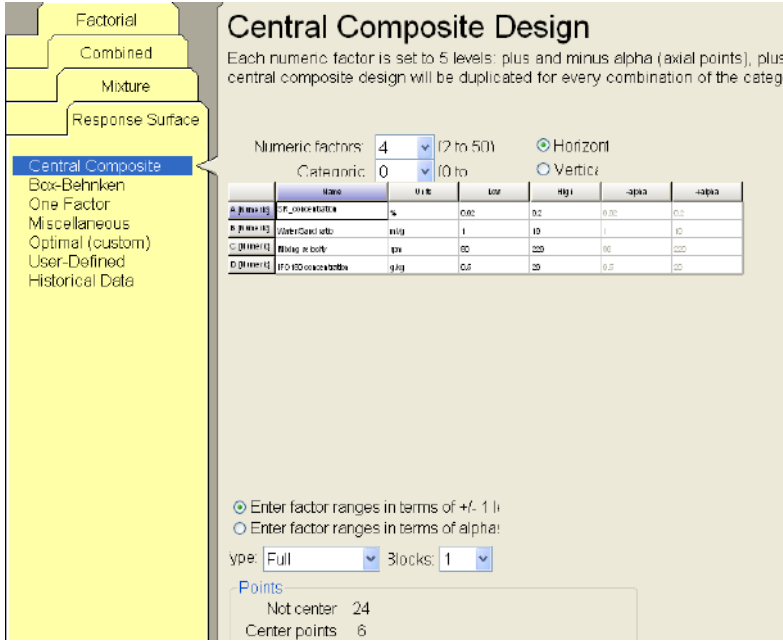

**Design of experiment** for TX, SL-1, HPB-CD, SR. A: surfactant concentration (% w/v), B: water: sand ratio (v/w), C: mixing rate (rpm), D: IFO180 concentration (g/kg). i) SL-1, HPB-CD, TX; ii) SR.

**Design of experiment** for surfactant-free water (blank). A: water: sand ratio (v/w), B: mixing rate (rpm), C: IFO180 concentration (g/kg).

Level	A	B	C	D
-1	$0.1^i - 0.01^{ii}$	1	80	0.5
0	$2.55^a - 0.11^b$	5.5	150	10.25
+1	$5^a - 0.2^b$	10	220	20

An example pf run's list with four factor (A, B, C, D) and Yeld responses (HC removal after 24 hour of washing):

Level	A	B	C
-1	1	80	0.5
0	5.5	150	10.25
+1	10	220	20

Notes for Sophorolipid_41	Std	Run	Factor 1 A:SR conc. g/100ml	Factor 2 B:Water:S mg	Factor 3 C:Mixing rate rpm	Factor 4 D:IFO180 c. g/g	Response 1 Yield 24 %
Design (Actual)	19	1	0.11	1	150	10.54	39.8
Summary	30	2	0.11	5.5	150	10.54	55.5
Graph Columns	16	3	0.2	10	220	15.71	62.4
Evaluation	12	4	0.2	10	80	15.71	18.7
Analysis	26	5	0.11	5.5	150	10.54	64.9
R1 Yield 24 (Analyz	27	6	0.11	5.5	150	10.54	62.9
Optimization	8	7	0.2	10	220	0.61	65.4
Numerical	11	8	0.02	10	80	15.71	6.2
Graphical	13	9	0.02	1	220	15.71	26.6
Post Analysis	2	10	0.2	1	80	0.61	42.3
Point Prediction	28	11	0.11	5.5	150	10.54	64.2
Confirmation	18	12	0.2	5.5	150	10.54	41.6
Coefficients Table	15	13	0.02	10	220	15.71	28.4
	1	14	0.02	1	80	0.61	45.7
	17	15	0.02	5.5	150	10.54	36.9
	5	16	0.02	1	220	0.61	55.5
	25	17	0.11	5.5	150	10.54	65.1
	10	18	0.2	1	80	15.71	22.9
	22	19	0.11	5.5	220	10.54	74.6
	14	20	0.2	1	220	15.71	19
	21	21	0.11	5.5	80	10.54	38.9
	24	22	0.11	5.5	150	15.71	42.6
	6	23	0.2	1	220	0.61	62.8
	7	24	0.02	10	220	0.61	60.5
	23	25	0.11	5.5	150	0.61	57.3
	29	26	0.11	5.5	150	10.54	54.6
	3	27	0.02	10	80	0.61	49.2
	20	28	0.11	10	150	10.54	73.2

30 washing tests were performed with each agent (20 tests for the surfactant-free control) under conditions combining the different levels for all investigated parameters. In this phase, each washing experiment was monitored after 24 hours. ANOVA was then applied to obtain the best fitting model describing the effect of the investigated parameters on hydrocarbons removal by each agent. Models were validated by performing additional washing tests using different conditions (i.e., combinations of surfactant concentration, water:sand ratio, mixing rate and IFO180 concentration) and comparing the observed removal efficiencies with those predicted by the model. Finally, optimal parameters for the washing of beach sand contaminated at different IFO180 concentrations were identified for each surfactant/mobilizing agent. In particular, two



optimization criteria were used:

- maximum hydrocarbons removal when all parameters are allowed to fall within the defined range (-1 to +1 level)
- maximum hydrocarbons removal when surfactant concentration and mixing range are allowed to fall within the defined range while minimizing the water:sand ratio.

[10] Design of Experiments (DOE) Made Easy

<https://www.statease.com/software/design-expert/>

<https://www.youtube.com/watch?v=y0QovZHeubM>

- **RESULTS: ANOVA 24h, model validation. Optimization criteria: Maximum and Optimum HC removal**

The ANOVA (Analysis of Variance) was applied to solve the following equation:

$$Y = \text{Cost} + aA + bB + cC + dD + abAB + acAC + \dots a^2A^2 + \dots$$

The simple model describes the effect of the investigated parameters (A, B, C, D) on hydrocarbons removal (Y) after 24h of treatment and can be represented by a response surface. Then, it is possible, to interrogate the model to find out the conditions of maximum removal, placing particular constraints, for example criteria i) and ii).

Model validation (experimental value versus the predicted value ); maximum HC removal prediction (%); optimum HC removal prediction (%) (minimizing the water:sand ratio), are shown for surfactant-free water, TX, SL-1, HPB-CD and SR.

it is pointed out that:

- Every surfactant has error associated to predicted removals at level confidence of 95%; and errors associated to observed removals are experimental errors.
- Blank – surfactant free water. The sand washing under optimal conditions allows to obtain HC removals in the range 30-48% depending on HC concentration;
- TX. Under optimal washing conditions, TX allows to obtain HC removals from 50% to 86% at increasing IFO180 concentrations;
- Both under optimal washing conditions and by minimizing the water amount used, HPB-CD and SR perform better than TX only at low hydrocarbons concentrations, but at lower surfactant concentration;



- Both under optimal washing conditions and by minimizing the water amount used, SL performs better than TX at all hydrocarbons concentrations and at lower surfactant concentration.

Blank : Model validation				
A Water/sand (v/w)	B Mixing rate (rpm)	C IFO180 conc. (g/kg)	HC removal predicted (%)	HC removal observed (%)
7	100	2.5	36.1 ± 5.4	33.3 ± 1.9
7	150	5	44.8 ± 5.4	44.9 ± 4.8
3	190	6.5	45.9 ± 5.4	43.9 ± 0.4
A Water/sand (v/w)	B Mixing rate (rpm)	C IFO180 conc. (g/kg)	Maximum HC removal predicted (%)	
			A,B,C : <i>in range</i> HC removal (%) : <i>maximum</i>	
1	220	0.5	40.2 ± 5.4	
1	220	2.5	43.2 ± 5.4	
10	220	6.5	47.9 ± 5.4	
10	220	10.25	47.3 ± 5.4	
10	220	20	29.5 ± 5.4	
A Water/sand (v/w)	B Mixing rate (rpm)	C IFO180 conc. (g/kg)	Optimum HC removal predicted (%)	
			C : <i>in range</i> , HC removal(%) : <i>maximum</i> B : <i>minimum</i>	
			predicted	observed
1	220	2.5	43.2 ± 5.4	42.4 ± 5.5
1	220	6.5	46.5 ± 5.4	44.4 ± 0.5
4.5	220	20	16.5 ± 5.4	21.5 ± 0.0



A TX (% w/v)	B Water/sand (v/w)	C Mixing rate (rpm)	D IFO 180 conc. (g/kg)	HC removal predicted (%)	HC removal observed (%)
1.8	7	100	2.5	59.7 ± 6.4	63.0 ± 0.3
2.55	7	150	5	72.3 ± 4.4	80.0 ± 0.0
0.5	3	190	6.5	72.4 ± 4.4	72.7 ± 0.1
TX : Maximum HC removal predicted (%) A, B, C : in range HC removal (%) : maximum					
5	10	80	0.5	51.0 ± 8.2	
5	10	80	2.5	62.5 ± 5.0	
5	10	220	6.5	79.7 ± 3.5	
5	10	220	10.25	86.2 ± 3.0	
5	10	220	20	86.0 ± 3.4	
TX : Optimum HC removal predicted (%) A, C : in range, HC removal (%) : maximum B : minimum					
				predicted	observed
5	1	220	2.5	49.5 ± 9.1	50.3 ± 9.1
5	1	220	6.5	76.9 ± 3.8	82.1 ± 1.0
5	1	220	20	80.5 ± 3.5	76.7 ± 1.6

A SL (% w/v)	B Water/sand (v/w)	C Mixing rate (rpm)	D IFO 180 conc. (g/kg)	HC removal predicted (%)	HC removal observed (%)
1.8	7	100	2.5	79.9 ± 7.3	73.3 ± 2.0
2.55	7	150	5	87.5 ± 7.3	82.3 ± 0.4
0.5	3	190	6.5	67.8 ± 7.3	68.3 ± 5.3
SL : Maximum HC removal predicted (%) A, B, C : in range HC removal (%) : maximum					
2.7	10	220	0.5	96.4 ± 7.3	
2.7	10	220	2.5	96.9 ± 7.3	
2.6	10	220	6.5	97.8 ± 7.3	
2.3	10	214	10.25	98.0 ± 7.3	
2.5	10	150	20	96.5 ± 7.3	
SL : Optimum HC removal predicted (%) A, C : in range HC removal (%) : maximum B : minimum					
				predicted	observed
2.7	1	220	2.5	82.3 ± 7.3	75.3 ± 2.3
2.6	1	220	6.5	83.2 ± 7.3	75.1 ± 1.9
2.6	1	150	20	81.9 ± 7.3	75.9 ± 2.4

A HPB-CD (% w/v)	B Water/sand (v/w)	C Mixing rate (rpm)	D IFO 180 conc. (g/kg)	HC removal predicted (%)	HC removal observed (%)
1.8	7	100	2.5	77.4 ± 7.1	68.5 ± 1.5
2.55	7	150	5	66.8 ± 7.1	58.9 ± 0.3
0.5	3	190	6.5	49.9 ± 7.1	52.3 ± 6.5
HPB-CD : Maximum HC removal predicted (%) A, B, C : in range HC removal (%) : maximum					
3.4	7.6	80	0.5	88.8 ± 7.1	
3.3	7.5	80	2.5	85.3 ± 7.1	
3.0	10	80	6.5	76.5 ± 7.1	
3.0	10	80	10.25	71.7 ± 7.1	
2.6	5.5	220	20	75.9 ± 7.1	
HPB-CD : Optimum HC removal predicted (%) A, C : in range HC removal (%) : maximum B : minimum					
				predicted	observed
3.3	1	85	2.5	82.9 ± 7.1	81.4 ± 0.4
3.0	1	80	6.5	74.3 ± 7.1	67.2 ± 0.6
2.6	1	150	20	72.6 ± 7.1	66.5 ± 2.6

A SR (% w/v)	B Water/sand (v/w)	C Mixing rate (rpm)	D IFO 180 conc. (g/kg)	HC removal predicted (%)	HC removal observed (%)
0.18	7	100	2.5	60.0 ± 8.6	62.8 ± 3.1
0.10	7	150	5	70.4 ± 8.6	63.0 ± 1.2
0.05	3	190	6.5	60.3 ± 8.6	59.5 ± 0.2
SR : Maximum HC removal predicted (%) A, B, C : in range HC removal (%) : maximum					
0.11	9.8	215	0.5	80.5 ± 8.6	
0.12	9.5	205	2.5	81.0 ± 8.6	
0.10	8.7	216	6.5	78.4 ± 8.6	
0.13	9.8	220	10.25	75.9 ± 8.6	
0.14	10	220	20	54.0 ± 8.6	
SR : Optimum HC removal predicted (%) A, C : in range HC removal (%) : maximum B : minimum					
				predicted	observed
0.11	1	220	2.5	71.1 ± 8.6	69.2 ± 1.3
0.11	1	220	6.5	69.8 ± 8.6	58.9 ± 1.5
0.11	1	220	20	40.7 ± 8.6	48.8 ± 7.5

- **PAH removal (%)**

In correspondence of the optimized conditions, samples were further analyzed in order to obtain the removing of PAH (%) from oil-contaminated sands compared to that of total hydrocarbons. was developed a protocol for n-alkane / PAH fraction separation using Upti - Clean SI/CN column. PAH compounds are environmentally critical because of their known toxicity, carcinogenicity and mutagenicity and presence in the environment.

Efficiency and removal mechanism of cyclodextrins in soil decontamination from PAH was studied by several authors [11,12,13,14,15,16], also was observed as microbial surfactants increase the apparent solubility of PAHs than 5 times compared to commercial products [17,18]. In IFO180 were identified a number of bi and tricycles compound: that represent 0.0042% (w/w) of IFO180.



Washing with no surfactant (blank) in optimal washing conditions for sands contaminated at different IFO180 concentrations: HC removal (%), n-alkanes removal (%), PAH removal (%)

Washing with TX in optimal washing conditions for sands contaminated at different IFO180 concentrations: HC removal (%), n-alkanes removal (%), PAH removal (%)

A – TX % (w/v)	B-Water/sand ratio (v/w)	C – Mixing rate (rpm)	D – IFO180 conc. (g/kg)	HC removal (%)	n-alkanes removal (%)	PAH removal (%)
1.8	7	100	2.5	63.0 ± 0.3	66.6 ± 1.2	83.2 ± 5.6
0.5	3	190	6.5	72.7 ± 0.1	72.0 ± 4.0	86.2 ± 1.8
5	1	220	2.5	68.9 ± 5.3	69.7 ± 7.9	87.8 ± 0.8
5	1	220	6.5	82.1 ± 1.0	81.9 ± 2.7	86.1 ± 6.8
5	1	220	20	76.7 ± 1.6	78.5 ± 1.3	81.3 ± 1.7



B-Water/Sand (ml/g)	C – Mixing rate (rpm)	D – IFO180 conc. (g/kg)	HC removal (%)	<i>n</i> -alkanes removal (%)	PAH removal (%)
7	100	2.5	33.3 ± 1.9	19.0 ± 0.2	49.6 ± 3.0
3	190	6.5	43.9 ± 0.4	23.0 ± 5.2	67.5 ± 1.2
1	220	2.5	42.4 ± 5.5	22.6 ± 8.2	43.1 ± 2.0
1	220	6.5	44.4 ± 0.5	29.0 ± 2.3	60.8 ± 7.8
4.5	220	20	21.5 ± 0.0	23.2 ± 0.7	42.5 ± 3.9

Washing with SL-1 in optimal washing conditions for sands contaminated at different IFO180 concentrations: HC removal (%), *n*-alkanes removal (%), PAH removal (%)

A – SL % (w/v)	B- Water/sand ratio (v/w)	C – Mixing rate (rpm)	D – IFO180 conc. (g/kg)	HC removal (%)	<i>n</i> -alkanes removal (%)	PAH removal (%)
1.8	7	100	2.5	73.3 ± 2.0	67.1 ± 2.4	79.4 ± 1.2
0.5	3	190	6.5	68.3 ± 5.3	63.7 ± 0.4	77.5 ± 4.1
2.7	1	220	2.5	75.3 ± 2.3	67.3 ± 1.3	77.3 ± 9.6
2.6	1	220	6.5	75.1 ± 1.9	60.0 ± 1.4	74.8 ± 1.6
2.6	1	150	20	75.9 ± 2.4	76.1 ± 2.5	82.5 ± 1.4

Washing with HPB-CD in optimal washing conditions for sands contaminated at different IFO180 concentrations: HC removal (%), *n*-alkanes removal (%), PAH removal (%)

A – HPB-CD % (w/v)	B-Water/Sand (ml/g)	C – Mixing rate (rpm)	D – IFO180 conc. (g/kg)	HC removal (%)	<i>n</i> -alkanes removal (%)	PAH removal (%)
1.8	7	100	2.5	68.5 ± 1.5	61.6 ± 1.3	82.1 ± 2.3
0.5	3	190	6.5	52.3 ± 3.5	43.3 ± 3.4	67.0 ± 0.8
3.3	1	85	2.5	81.4 ± 0.4	67.8 ± 3.6	82.1 ± 3.3
3.0	1	80	6.5	67.2 ± 0.6	62.1 ± 0.2	67.1 ± 1.0
2.6	1	150	20	66.5 ± 2.6	62.3 ± 1.3	73.0 ± 4.0

Washing with SR in optimal washing conditions for sands contaminated at different IFO180 concentrations: HC removal (%), *n*-alkanes removal (%), PAH removal (%)

A – SR % (w/v)	B- Water/sand ratio (v/w)	C – Mixing rate (rpm)	D – IFO180 conc. (g/kg)	HC removal (%)	<i>n</i> -alkanes removal (%)	PAH removal (%)
0.18	7	100	2.5	62.8 ± 3.1	51.3 ± 4.6	67.4 ± 5.9
0.05	3	190	6.5	59.5 ± 0.2	49.2 ± 5.4	60.6 ± 4.3
0.11	1	220	2.5	69.2 ± 1.3	56.6 ± 6.1	83.5 ± 2.8
0.11	1	220	6.5	58.9 ± 1.5	38.0 ± 4.4	91.9 ± 0.1
0.11	1	220	20	48.8 ± 7.5	34.4 ± 2.2	62.9 ± 7.3



## Glossary of Terms

Term (alphabetical order)	Definition
SL-1	<i>Soy lecithin commercial products: SOLEC™ F</i>
SL-2	<i>Soy lecithin commercial products: TEXTROL™ F</i>
HPB-CD	<i>Hydroxypropyl-β-cyclodextrin</i>
RAMEB	<i>Randomly methylated β-cyclodextrin</i>
BB	<i>Bovine bile acids</i>
SR	<i>Sophorolipids</i>
RL	<i>Rhamnolipids</i>
SF	<i>Surfactin</i>
TX	<i>Triton X-100</i>
PAH	<i>Polycyclic Aromatic Hydrocarbon</i>
DoE	<i>Design of experiment</i>
CCD	<i>Central Composite Design</i>
SD	<i>Standard Deviation</i>

[11] Wang JM., Marlowe EM., Miller-Maier RM., Brusseau ML (1998) Cyclodextrin enhanced biodegradation of phenanthrene. *Environ. Sci. Technol.* 32, 1907–1912

[12] Ye M, Sun M, Kengara FO, Wang J, Ni N, Wang L, Song Y, Yang X, Li H, Hu F, Jiang X (2014) Evaluation of soil washing process with carboxymethyl-β-cyclodextrin and carboxymethyl chitosan for recovery of PAHs/heavy metals/fluorine from metallurgic plant site. *J Environ Sci (China)* 26(8):1661-72

[13] Petitgirard A, Djehiche M, Persello J, Fievet P, Fatin-Rouge N (2009) PAH contaminated soil remediation by reusing an aqueous solution of cyclodextrins. *Chemosphere* 75:714-718

[14] Von Lau E, Gan S, Ng HK, Poh PE (2014) Extraction agents for the removal of polycyclic aromatic hydrocarbons (PAHs) from soil in soil washing technologies. *Environmental Pollution* 181:640-649

[15] Peng S, Wu W, Chen J (2011) Removal of PAHs with surfactant-enhanced soil washing: Influencing factors and removal effectiveness. *Chemosphere* 82:1173-1177

[16] Sánchez-Trujillo MA, Morillo E, Villaverde J, Lacorte S (2013) Comparative effects of several cyclodextrins on the extraction of PAHs from an aged contaminated soil. *Environmental Pollution* 178:52-58

[17] Heyd M, Kohnert A, Tan TH, Nusser M, KirschhÄfer F, Brenner-Weiss G, et al. (2008) Development and trends of biosurfactant analysis and purification using rhamnolipids as an example. *Analytical and Bioanalytical Chemistry* 391(5): 1579-90

[18] Nitschke M, Araújo L, Costa S, Pires R, Zeraik A, Fernandes A, et al. (2009) Surfactin reduces the adhesion of food borne pathogenic bacteria to solid surfaces. *Letters in applied microbiology* 49(2): 241-7

## 1. Your contact details - CASE STUDY: SW n.6

<b>1.1. Name and Surname*</b>	Prof. Dr. Domen Lestan
<b>1.2. Country/Jurisdiction</b>	Slovenia
<b>1.3. Organisation</b>	Envit Ltd.
<b>1.4. Position</b>	Assistant assistant manager & CTO of Envit Ltd.
<b>1.5. Duties</b>	Full professor at Biotechnical Faculty, University of Ljubljana
<b>1.6. Email address</b>	info@envit.si domen.lestan@bf.uni-lj.si
<b>1.7. Phone number</b>	<a href="tel:+38659924819">+386 59 924 819</a>

## 2. Site background

### 2.1 History of the site

In 1992 the Pb/Zn smelter (**Figure 1**) at Arnoldstein (Austria) closed and emissions ceased. Several hundred years of emissions (Pb, Zn, Cd, and to a lesser extent Cu, As) were dispersed over the surrounding area, which was used for housing (play- grounds), horticulture, forestry, and agriculture. The smelting activities at Arnoldstein date back to 1495, beginning with the smelting of lead, followed, in the 1950's, by the production of zinc, cadmium, and germanium. Besides the roasting and smelting of metal ores, different substances such as fertilisers (superphosphate), sulfuric acid, and dye- stuffs were also produced. Official emission figures were provided for 1989 by the Carinthian State government for SO<sub>2</sub> (1377 t a<sup>-1</sup>), and metals (total dust up to 41.9 t a<sup>-1</sup>, of which 13.5 t a<sup>-1</sup> was Pb-dust). By 1992 these emissions were reduced for SO<sub>2</sub> to 570 t a<sup>-1</sup> and for metals (total dust) to 25.5 t a<sup>-1</sup>, of which 8.9 t a<sup>-1</sup> was Pb-dust (Kasperowski, 1993). In the 1960s emission controls were improved but focused only on SO<sub>2</sub> because of concerns relating to forest decline. The persistent heavy metals were not considered a priority at that time. The emissions consisted mainly of oxides and sulfides (Zn, Cd), sulfates (Zn, Pb, and Cd), chloride (Pb), and carbonate (Cd) (Halbwachs et al., 1982).



**Figure 1:** Lead smelter in Arnoldstein.

## 2.2 Geological setting

Arnoldstein (46°3'N, 13°42'E) is located in southern Carinthia, Austria, near the borders of Italy and Slovenia. The topography of the area is uniform at 560 m above sea level, except for some low hills originating from a landslide of the Villacher Alpe in 1348. Surrounding mountain ranges result in a typical, persistent inversion weather situation in autumn and winter. The heterogeneous soils were formed on prehistoric, limey material and replenished by glacial and alluvial sediments (Rabitsch, 1994).

The surroundings of the Pb/Zn-smelter show different geological and pedological properties. Glacial sediments (**Figure 2**) covered the western part where mostly Dystric Cambisols (WRB) have developed.



**Figure 2:** Grassland in Arnoldstein used as experimental site.

## 2.3 Contaminants of concern

Toxic metals and its concentrations:

- Lead - 795 mg/kg,
- Cadmium - 4.5 mg/kg,
- Zinc - 484 mg/kg.



## 2.4 Regulatory framework

*In Austrian legislation there is ÖNORM S 2088-2:2014 standard which deals with Contaminated sites - Part 2: Use-specific assessment of soil contamination from old sites and old landfills. In this standard guide values for pollutant levels in the soil (0-20cm) for plant production in the use class agriculture and horticulture. Lead level should not exceeded 100mg/kg, cadmium 0.5 mg/kg and cink 300 mg/kg. Reference values for assessing the mobilizable element content in the  $\text{NH}_4\text{NO}_4$  extract of soil samples with regard to soil-plant transfer are also included. For lead 100  $\mu\text{g}/\text{kg}$  and Cadium 40  $\mu\text{g}/\text{kg}$  value represent a risk of impairment of the quality of the food plants or fodder plants based on ÖNORM S 2088-2:2014.*

## 3. Pilot-scale application in field

### 3.1 Soil washing system

Washing solution is made by 60 mM EDTA (65% of calcium form, 20% of acid form, 15 % of sodium form). Soil/water ratio is 1:1. Soil are after filtration in filter press 3 times rinsed with recycled solution from previous batch and at the end with fresh water. Fresh water was added to the system to compensate for the losses of process water: due to the moisture difference between the soil entering and leaving the process, water lost with the wet solid wastes, and the hydration of the quicklime (**Figure 3**).



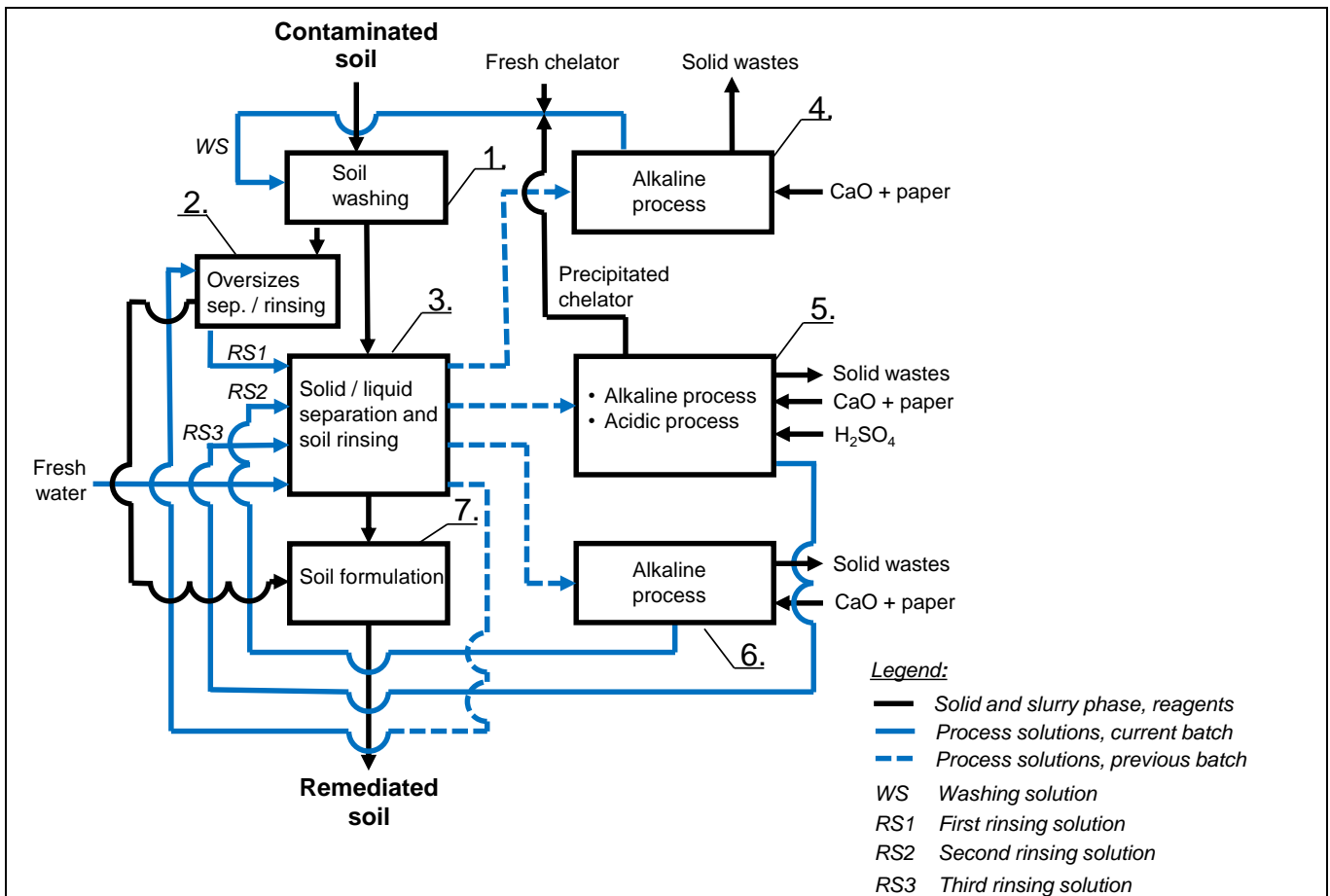

**Figure 3:** The flowchart of ReSoil® soil remediation process with material mass flows per batch. The used RS1 (uRS1) from the previous batch is not treated; it issued directly as RS1 in the current batch. The used WS (uWS), used RS2 (uRS2), and used RS3 (uRS3) are treated by alkanization with quicklime (CaO, pH > 12, 30 min) to remove toxic metals and recycle the chelator in the form of Ca salt (steps 6, 7, 8). The uWS, uRS3 and uRS2 are treated with waste paper for alkaline adsorption of toxic metals. The waste paper is applied into the uRS2 in step 6 and separated from the solution (RS2) by a filter press after 10 min of adsorption reaction. The paper from step 6 is reused in the same way, first in step 7 and then in step 8. Solid waste: hydrated lime from step 6, 7, 8 and the final paper enriched with toxic metals from step 8 is removed from the process solutions by filtration and disposed of safely. The uRS3 is acidified to pH 2 in step 7 by adding 96% H<sub>2</sub>SO<sub>4</sub> to precipitate and recover (120 min reaction time) the remaining chelator in acidic form by filter press. The recycled WS is then prepared by adding acidic and fresh chelator to compensate for the loss of chelator in the process: the chelator is removed with the waste and bound to ZVI in the soil solid phase. ReSoil® is designed as a close loop process (circular economy), everything is designed to have no negative impact on the environment, everything is emission free (no leakage, no gaseous emissions, only solid waste).



## 3.2 Feasibility study

The important parameter is difference between stability of EDTA-toxic metals complex and stability of chemicals form of toxic metals present in soil. The toxic metals which could not be removed by ReSoil® process are biological and chemical unattainable. Most of toxic metals after remediation is present in soil as soil minerals, which are inert and non-toxic.

Important parameter is also soil functionality and purpose to use soil as plant substrat after remediation:

Common biological indicators of soil quality (**Figure 4**) were used to assess soil functioning.

	<u>Original</u>	<u>Remediated</u>
<u>pH (water)</u>	<u>5.86</u>	<u>7.14</u>
<u>SOC (%)</u>	<u>2.86</u>	<u>2.93</u>
<u>C/N</u>	<u>9.5</u>	<u>10.1</u>
<u>P<sub>2</sub>O<sub>5</sub> (mg kg<sup>-1</sup>)</u>	<u>116</u>	<u>63</u>
<u>K<sub>2</sub>O (mg kg<sup>-1</sup>)</u>	<u>91</u>	<u>132</u>
<u>Sand (%)</u>	<u>38.2</u>	<u>32.8</u>
<u>Silt (%)</u>	<u>47.2</u>	<u>49.9</u>
<u>Clay (%)</u>	<u>14.6</u>	<u>17.3</u>
<u>CEC<sub>eff</sub> (cmol<sub>c</sub> kg<sup>-1</sup>)</u>	<u>13.4</u>	<u>11.3</u>

**Figure 4:** Standard pedological analysis of soil.

## 3.3 Water Treatment

ReSoil® soil washing process does not produce waste water. All solution which are used are recycled in a closed process loop.

## 3.4 Control parameters

Field monitoring and sampling program that will adequately monitor the effectiveness of the treatment in three dimensions.

- Leaching of EDTA and metal complex from remediated soil.
- Checking soil rinsing efficiency in large filter press.

## 4. Full-scale application

### 4.1 Soil washing system

In ReSoil® (**Figure 5**) the soil is excavated and grid sieved to remove oversize material. Soil is washed in mixer to remove Pb and other toxic metals (Zn, Cd). Washing solution contain ethylenediamine tetraacetate (EDTA), as washing agent. The mechanisms of contaminants removal are explained bellow (**Figure 6**). In a downstream process, the washed soil will be rinsed in a filter press with three consecutive rinsing solutions recycled from the previous batch and with fresh water to compensate for water losses.

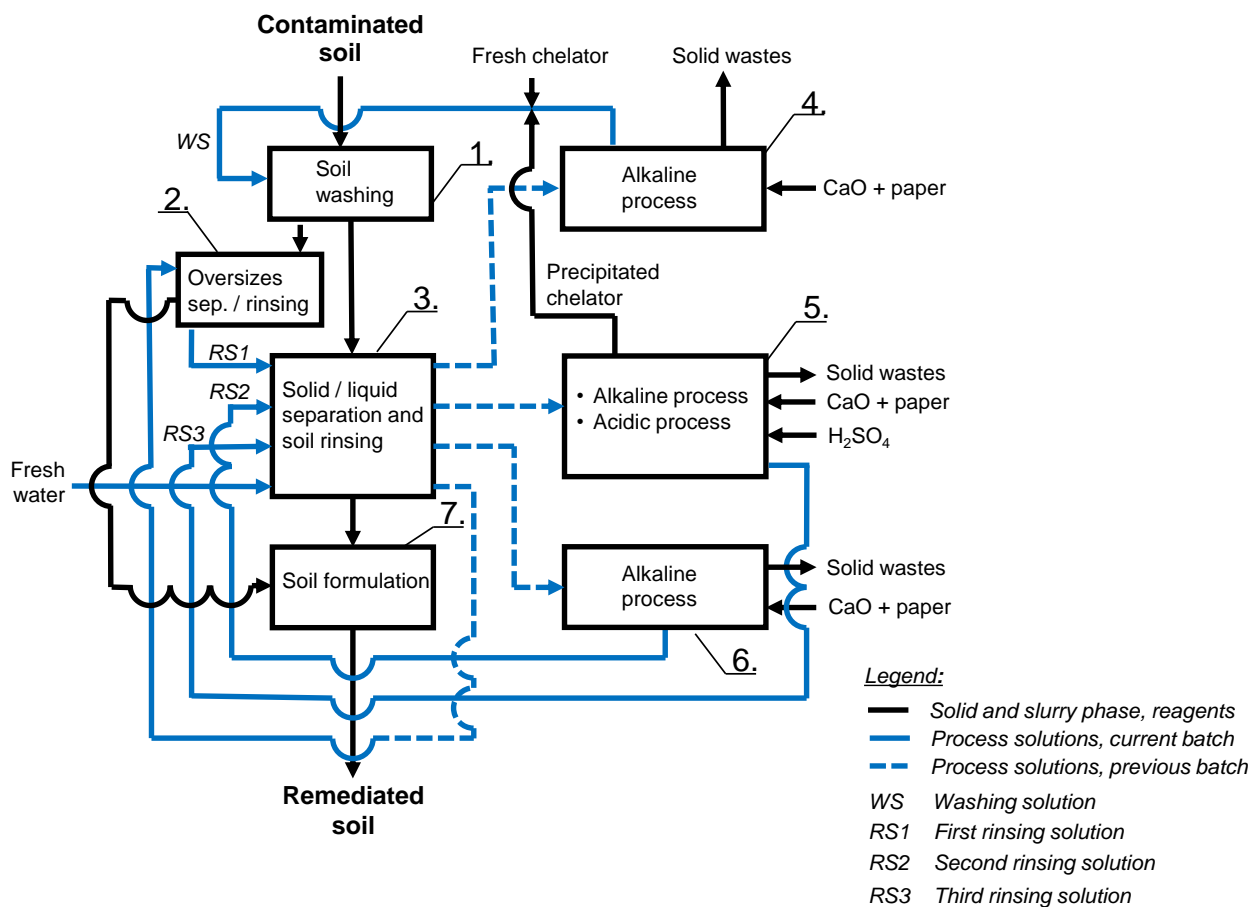

**Figure 5:** The flowchart of ReSoil® soil remediation process with material mass flows per batch.

## ReSoil® technology – Pb example

EDTA-based soil-washing efficiently remove Pb and other heavy metals from soil:

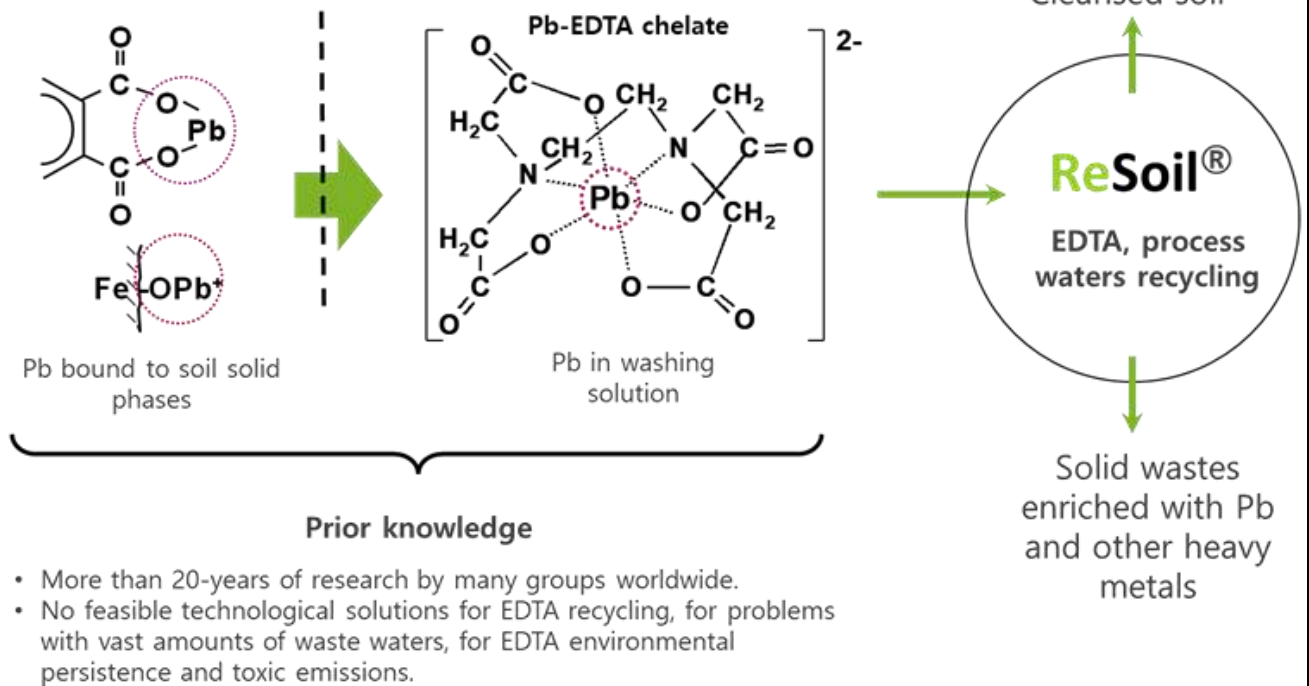

**Figure 6:** Example of successful Pb removal with ReSoil® technology.

Washing solution is made by EDTA (65% of calcium form, 20% of acid form, 15 % of sodium form). Soil/water ratio is 1:1. Soil are after filtration in filter press 3 times rinsed with recycled solution from previous batch and at the end with fresh water. Fresh water was added to the system to compensate for the losses of process water (**Figure 7**): due to the moisture difference between the soil entering and leaving the process, water lost with the wet solid wastes, and the hydration of the quicklime.



**Figure 7:** Stationary ReSoil® facility with capacity of 6 t/day constructed under [LIFE+ programme](#).

The used RS1 (uRS1) from the previous batch is not treated; it issued directly as RS1 in the current batch. The used WS (uWS), used RS2 (uRS2), and used RS3 (uRS3) are treated by alkanization with quicklime (CaO, pH > 12, 30 min) to remove toxic metals and recycle the chelator in the form of Ca salt (steps 6, 7, 8). The uWS, uRS3 and uRS2 is treated with waste paper for alkaline adsorption of toxic metals. The waste paper is applied into the uRS2 in step 6 and separated from the solution (RS2) by a filter press after 10 min of adsorption reaction. The paper from step 6 is reused in the same way, first in step 7 and then in step 8. Solid waste: hydrated lime from step 6, 7, 8 and the final paper enriched with toxic metals from step 8 is removed from the process solutions by filtration and disposed of safely. The uRS3 is acidified to pH 2 in step 7 by adding 96% H<sub>2</sub>SO<sub>4</sub> to precipitate and recover (120 min reaction time) the remaining chelator in acidic form by filter press. The recycled WS is then prepared by adding acidic and fresh chelator to compensate for the loss of chelator in the process: the chelator is removed with the waste and bound to ZVI in the soil solid phase. Process is made in closed cycle loop (described above). In demonstrational plant (**Figure 7**) we are able remediated 1 ton of soil per day, with possibility to work 6 ton per day.



## 4.2 Feasibility study

The feasibility of ReSoil® novel soil remediation technology can be made in small scale. Only 1kg of soil is needed to make pre-treatment experiment to check efficiency of EDTA (concentration selection of EDTA).

## 4.3 Water Treatment

ReSoil® soil washing process does not produce waste water. All solution which are used are recycled in a closed process loop.

## 4.4 Control parameters

Field monitoring and sampling program that will adequately monitor the effectiveness of the treatment in three dimensions.

To assess the removal efficiency, the contaminants of concern are measured at the output of any washing cycle. Remediated soil water extraction test is used for assessing soil leaching suitability, by measuring toxic metals and EDTA concentration in extracts.

# 5. Results

## 5.1 Removal rate

The average concentrations of toxic metals were 759 mg/kg Pb, 484 mg/kg Zn and 4.5 mg/kg Cd in the original soil and 189 mg/kg Pb, 409 mg/kg Zn and 2.4 mg/kg Cd in the remediated soil. On average, remediation reduced the concentration of Pb, Zn and Cd by 76, 15 and, 47%, respectively. Zn removal was characterized by lower extractability, likely due to the predominant Zn association with non-labile soil fractions.

The mobilizable element content in the  $\text{NH}_4\text{NO}_3$  extract of soil samples with regard to soil-plant transfer was reduced for lead by 61.3 %, cadmium 63,3% and zinc 97,7%.

Overall, the sequential extraction results suggest that most of the toxic metals remaining in the soil after ReSoil® were allocated in non-labile soil fractions, making them less accessible and hazardous.

## 6. Post treatment and/or Long Term Monitoring

### 6.1 Post treatment and/or Long Term Monitoring

We conducted raised (demonstrational) bed experiments (**Figure 8**). Demonstrational beds filled with homogenised remediated soil are constructed as lysimeters with drainage system for collection / sampling of soil leachates. The purpose of lysimeter beds was to demonstrate through monitoring that ReSoil® process does not produce toxic emissions / leachates e.g. prevents emissions into environment. Fast growing, all season plant species e.g. buckwheat were used. Lysimeters are installed in beds for easy to sample leachate collection: toxic metals and EDTA in leachates were measured.

We monitored different parameters like:

- leaching of toxic metals and EDTA
- soil physical properties
- soil biological properties (microbial activity)
- plant growth and toxic metal accumulation



**Figure 8:** Vegetable garden with remediated soil as a concept of post treatment as a/or longterm monitoring. The growth of chiness cabbage and beans is depicted.

Remediation enables growth of healthy and safe vegetables on Arnoldstein soil. Toxic metal uptake in Spinach, Radish, Chinese Cabbage and Bush Beans was reduced by over 80%. Biomass production on the remediated soil was systematically increased for all vegetables.



## 7. Additional information

### 7.1 Lesson learnt

#### **1) methodology and procedures**

Procedure was very effective, there was no problems with recycling solutions. Equipment even on larger scale did here job as it should. There is some room for improvement of reduction dangerous waste after solutions recycling.

#### **2) technical aspects**

Tranfering contaminated soil trough border. After excavation soil is managed as hazarouds waste and a lot fo papers is needed to tranfer soil for on country to another.

#### **3) organizational aspects**

From organizational aspect we can say that it is very inportant to use right dissemination of the procedures. If local people are scared of your process is hard to work in that environment.

### 7.2 Additional information

Toxic metal fractionation, more mobile fraction better success of remediation.

### 7.4 Additional remarks

Remediated soil as an active ecosystem

Analysis of soil total C and N, DOC, NH<sub>4</sub>, NO<sub>3</sub>, microbial community (total microbial biomass, PLFA) and soil respiration indicated higher ecosystem activity and C/N turnover in remediated soil. Key soil micro- and mesofauna was preserved.

## Glossary of Terms

<b>Term (alphabetical order)</b>	<b>Definition</b>
ZVI (Fe <sup>0</sup> )	Zero valent iron
EDTA	ethylenediamine tetraacetate
H <sub>2</sub> SO <sub>4</sub>	Sulfuric acid
CaO	Quick lime